



TE 50
TE 50-AVR

English

TE 50

TE 50-AVR

Original operating instructions

1 Information about the documentation

1.1 About this documentation

- Read this documentation before initial operation or use. This is a prerequisite for safe, trouble-free handling and use of the product.
- Observe the safety instructions and warnings in this documentation and on the product.
- Always keep the operating instructions with the product and make sure that the operating instructions are with the product when it is given to other persons.

1.2 Explanation of symbols used

1.2.1 Warnings

Warnings alert persons to hazards that occur when handling or using the product. The following signal words are used:

DANGER

DANGER !

- ▶ Draws attention to imminent danger that will lead to serious personal injury or fatality.

WARNING

WARNING !

- ▶ Draws attention to a potential threat of danger that can lead to serious injury or fatality.





CAUTION

CAUTION !

- ▶ Draws attention to a potentially dangerous situation that could lead to slight personal injury or damage to the equipment or other property.

1.2.2 Symbols in the documentation

The following symbols are used in this document:

	Read the operating instructions before use.
	Instructions for use and other useful information
	Dealing with recyclable materials
	Do not dispose of electric equipment and batteries as household waste

1.2.3 Symbols in the illustrations

The following symbols are used in illustrations:

2	These numbers refer to the corresponding illustrations found at the beginning of these operating instructions
3	The numbering reflects the sequence of operations shown in the illustrations and may deviate from the steps described in the text
⑪	Item reference numbers are used in the overview illustrations and refer to the numbers used in the product overview section
	This symbol is intended to draw special attention to certain points when handling the product.

1.3 Product-dependent symbols

1.3.1 Symbols on the product

The following symbols are used on the product:

	Drilling with hammer action (hammer drilling)
	Chiseling
	Chisel positioning
	Protection class II (double-insulated)
/min	Revolutions per minute
n_0	Rated speed under no load
\emptyset	Diameter
	Wireless data transfer

1.4 Product information

products are designed for professional users and only trained, authorized personnel are permitted to operate, service and maintain the products. This personnel must be specifically informed about the possible hazards. The product and its ancillary equipment can present hazards if used incorrectly by untrained personnel or if used not in accordance with the intended use.

The type designation and serial number are printed on the rating plate.

- ▶ Write down the serial number in the table below. You will be required to state the product details when contacting Hilti Service or your local Hilti organization to inquire about the product.

Product information

Combihammer	TE 50-AVR
Generation	03
Serial no.	

1.5 Declaration of conformity

We declare, on our sole responsibility, that the product described here complies with the applicable directives and standards. A copy of the declaration issued by the certification department can be found at the end of this documentation.

The technical documentation is filed here:

Hilti Entwicklungsgesellschaft mbH | Tool Certification | Hiltistrasse 6 | 86916 Kaufering, Germany

2 Safety

2.1 General power tool safety warnings

WARNING

Read all safety warnings and all instructions. Failure to follow the warnings and instructions may result in electric shock, fire and/or serious injury.

Save all warnings and instructions for future reference.

The term “power tool” in the warnings refers to your mains-operated (corded) power tool or battery-operated (cordless) power tool.

Work area safety

- ▶ **Keep work area clean and well lit.** Cluttered or dark areas invite accidents.
- ▶ **Do not operate power tools in explosive atmospheres, such as in the presence of flammable liquids, gases or dust.** Power tools create sparks which may ignite the dust or fumes.
- ▶ **Keep children and bystanders away while operating a power tool.** Distractions can cause you to lose control.

Electrical safety

- ▶ **Power tool plugs must match the outlet. Never modify the plug in any way. Do not use any adapter plugs with earthed (grounded) power tools.** Unmodified plugs and matching outlets will reduce risk of electric shock.
- ▶ **Avoid body contact with earthed or grounded surfaces, such as pipes, radiators, ranges and refrigerators.** There is an increased risk of electric shock if your body is earthed or grounded.
- ▶ **Do not expose power tools to rain or wet conditions.** Water entering a power tool will increase the risk of electric shock.
- ▶ **Do not abuse the cord. Never use the cord for carrying, pulling or unplugging the power tool. Keep cord away from heat, oil, sharp edges or moving parts.** Damaged or entangled cords increase the risk of electric shock.
- ▶ **When operating a power tool outdoors, use an extension cord suitable for outdoor use.** Use of a cord suitable for outdoor use reduces the risk of electric shock.

- ▶ **If operating a power tool in a damp location is unavoidable, use a residual current device (RCD) protected supply.** Use of an RCD reduces the risk of electric shock.

Personal safety

- ▶ **Stay alert, watch what you are doing and use common sense when operating a power tool. Do not use a power tool while you are tired or under the influence of drugs, alcohol or medication.** A moment of inattention while operating power tools may result in serious personal injury.
- ▶ **Use personal protective equipment. Always wear eye protection.** Protective equipment such as dust mask, non-skid safety shoes, hard hat, or hearing protection used for appropriate conditions will reduce personal injuries.
- ▶ **Prevent unintentional starting. Ensure the switch is in the off-position before connecting to power source and/or battery pack, picking up or carrying the tool.** Carrying power tools with your finger on the switch or energising power tools that have the switch on invites accidents.
- ▶ **Remove any adjusting key or wrench before turning the power tool on.** A wrench or a key left attached to a rotating part of the power tool may result in personal injury.
- ▶ **Do not overreach. Keep proper footing and balance at all times.** This enables better control of the power tool in unexpected situations.
- ▶ **Dress properly. Do not wear loose clothing or jewellery. Keep your hair, clothing and gloves away from moving parts.** Loose clothes, jewellery or long hair can be caught in moving parts.
- ▶ **If devices are provided for the connection of dust extraction and collection facilities, ensure these are connected and properly used.** Use of dust collection can reduce dust-related hazards.

Power tool use and care

- ▶ **Do not force the power tool. Use the correct power tool for your application.** The correct power tool will do the job better and safer at the rate for which it was designed.
- ▶ **Do not use the power tool if the switch does not turn it on and off.** Any power tool that cannot be controlled with the switch is dangerous and must be repaired.
- ▶ **Disconnect the plug from the power source and/or the battery pack from the power tool before making any adjustments, changing accessories, or storing power tools.** Such preventive safety measures reduce the risk of starting the power tool accidentally.
- ▶ **Store idle power tools out of the reach of children and do not allow persons unfamiliar with the power tool or these instructions to operate the power tool.** Power tools are dangerous in the hands of untrained users.

- ▶ **Maintain power tools. Check for misalignment or binding of moving parts, breakage of parts and any other condition that may affect the power tool's operation. If damaged, have the power tool repaired before use.** Many accidents are caused by poorly maintained power tools.
- ▶ **Keep cutting tools sharp and clean.** Properly maintained cutting tools with sharp cutting edges are less likely to bind and are easier to control.
- ▶ **Use the power tool, accessories and tool bits etc. in accordance with these instructions, taking into account the working conditions and the work to be performed.** Use of the power tool for operations different from those intended could result in a hazardous situation.

Service

- ▶ **Have your power tool serviced by a qualified repair person using only identical replacement parts.** This will ensure that the safety of the power tool is maintained.

2.2 Hammer safety warnings

- ▶ **Wear ear protectors.** Exposure to noise can cause hearing loss.
- ▶ **Use auxiliary handles, if supplied with the tool.** Loss of control can cause personal injury.
- ▶ **Hold power tool by insulated gripping surfaces, when performing an operation where the cutting accessory may contact hidden wiring or its own cord.** Cutting accessory contacting a "live" wire may make exposed metal parts of the power tool "live" and could give the operator an electric shock.

2.3 Additional safety instructions

Personal safety

- ▶ Use the product only when it is in technically faultless condition.
- ▶ Never tamper with or modify the power tool in any way.
- ▶ Apply appropriate safety measures at the opposite side of the workpiece in work that involves breaking through. Parts breaking away could fall out and / or fall down causing injury to other persons.
- ▶ Always hold the power tool with both hands on the grips provided. Keep the grips clean and dry.
- ▶ Always grip the side handle at its outermost end. When drilling and screwdriving, the grip of the power tool may be deflected laterally (the power tool tends to pivot about its own axis).
- ▶ Avoid touching rotating parts – risk of injury!
- ▶ Wear suitable protective glasses, a hard hat, ear protection, protective gloves and light respiratory protection while using the power tool.
- ▶ Wear protective gloves also when changing the accessory tool. Touching the accessory tool presents a risk of injury (cuts or burns).

- ▶ Wear eye protection. Flying fragments present a risk of injury to the body and eyes.
- ▶ Before beginning the work, check the hazard classification of the dust that will be produced. Use an industrial vacuum cleaner with an officially approved protection classification in compliance with locally applicable dust protection regulations.
- ▶ Use a dust removal system and suitable vacuum cleaner whenever possible. Dust from materials, such as paint containing lead, some wood species, concrete/masonry/stone containing silica, and minerals as well as metal, may be harmful.
- ▶ Make sure that the workplace is well ventilated and, where necessary, wear a respirator appropriate for the type of dust generated. Contact with or inhalation of the dust may cause allergic reactions and/or respiratory or other diseases to the operator or bystanders. Certain kinds of dust are classified as carcinogenic such as oak and beech dust, especially in conjunction with additives for wood conditioning (chromate, wood preservative). Material containing asbestos may be handled only by specialists.
- ▶ Take breaks between working and do physical exercises to improve the blood circulation in your fingers. Exposure to vibration during long periods of work can lead to disorders of the blood vessels and nervous system in the fingers, hands and wrists.

Electrical safety

- ▶ Before beginning work, check the working area for concealed electric cables or gas and water pipes. External metal parts of the power tool may become live, presenting a risk of electric shock, if you damage an electric cable accidentally.

Careful handling and use of power tools

- ▶ Switch the power tool off if the accessory tool sticks and stalls. The power tool may be deflected laterally.
- ▶ Wait until the power tool stops completely before you lay it down.

3 Description

3.1 Overview of the product

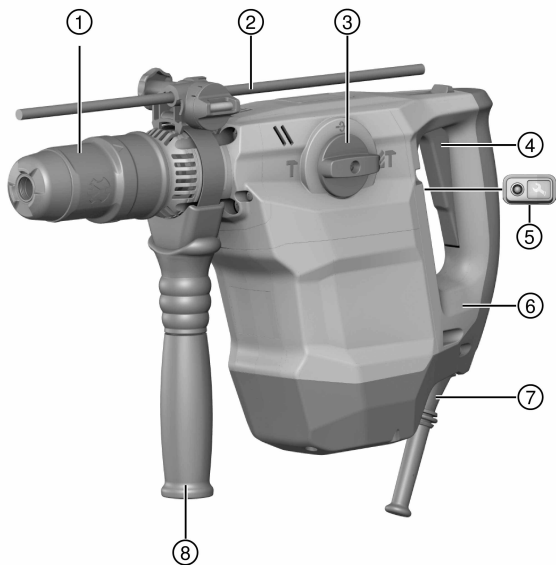

- | | |
|----------------------------|---------------------|
| ① Chuck | ⑤ Service indicator |
| ② Depth gauge | ⑥ AVR |
| ③ Function selector switch | ⑦ Supply cord |
| ④ Control switch | ⑧ Side handle |

3.2 Version with detachable supply cord

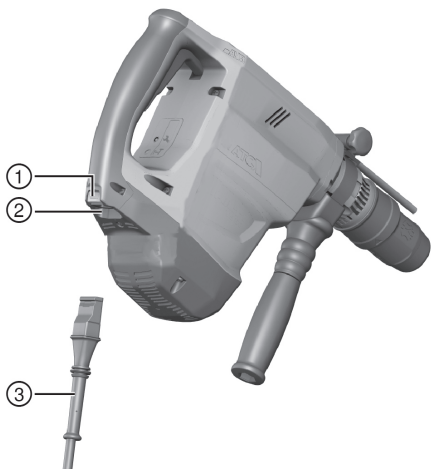

- | | |
|------------------------------|--|
| ① Lockbutton | ③ Supply cord with keyed, re-
leasable plug connector |
| ② Connector on electric tool | |

3.3 Intended use

The product described is an electrically-powered combihammer with pneumatic hammering mechanism. It is designed for drilling in concrete, masonry, wood and metal. The product can also be used for light to medium-duty chiseling on masonry and surface finishing work on concrete.

- ▶ Operation is permissible only when connected to a power source providing a voltage and frequency in compliance with the information given on the type identification plate.

3.4 Possible misuse

- This product is not suitable for working on hazardous materials.

- This product is not suitable for working in a damp environment.

3.5 Active Vibration Reduction

The tool is equipped with an Active Vibration Reduction (AVR) system which reduces vibration noticeably.

3.6 Quick-release chuck (accessory)

The quick-release chuck makes it possible to change accessory tools quickly, without need for a chuck key (keyless system). It is suitable for accessory tools with a cylindrical or hexagonal shank, such as drill bits for wood and metal, or mixing paddles, which are used in the rotary-only mode (without hammering action) .

3.7 Service indicator

The product has an LED service indicator.

Status	Meaning
Service indicator shows	Servicing is due.
Service indicator flashes	The product is faulty. Have the combihammer repaired by Hilti Service .

3.8 Items supplied

Combihammer, side handle, operating instructions.

Other system products approved for use with this product can be found at your local **Hilti Store** or online at: www.hilti.group.

4 Technical data

 For rated voltage, rated current, frequency and/or input power, refer to the country-specific type identification plate.

If the device is powered by a generator or transformer, the generator or transformer's power output must be at least twice the rated input power shown on the rating plate of the device. The operating voltage of the transformer or generator must always be within +5 % and -15 % of the rated voltage of the device.

	TE 50-AVR
Weight (without supply cord)	13.4 lb (6.1 kg)
Storage temperature	-4 °F ... 158 °F (-20 °C ... 70 °C)

	TE 50-AVR
Ambient temperature for operation	1 °F ... 140 °F (-17 °C ... 60 °C)
Ø hammer drill bits	1/2 in ... 1 1/4 in
Ø hammer drill bits	12 mm ... 32 mm
Ø drill bits for wood	1/4 in ... 1 3/8 in
Ø drill bits for wood	6 mm ... 35 mm
Ø drill bits for metal	1/4 in ... 1/2 in
Ø drill bits for metal	6 mm ... 13 mm

5 Operation

5.1 Preparations at the workplace

⚠ CAUTION

Risk of injury! Inadvertent starting of the product.

- ▶ Unplug the supply cord before making adjustments to the power tool or before changing accessories.

Observe the safety instructions and warnings in this documentation and on the product.

5.1.1 Fitting the side handle

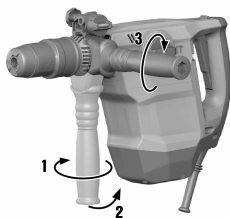

1. Release the side handle clamping band by turning the handle grip.
2. Slide the side handle clamping band over the chuck from the front and into the recess provided.
3. Bring the side handle into the desired position.
4. Tighten the side handle clamping band by turning the handle grip.

5.1.2 Fitting the depth gauge (optional)

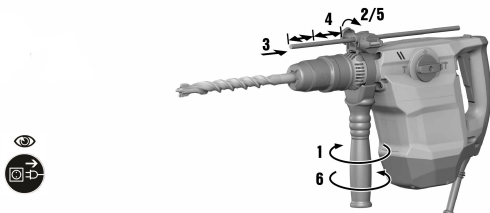

1. Release the side handle clamping band by turning the handle grip.
2. Slide the depth gauge from the front into the 2 guide holes provided.
3. Tighten the side handle clamping band by turning the handle grip.
 - ↳ The depth gauge is fitted. To set the drilling depth:
4. Release the screw at the depth gauge.
5. Adjust the depth gauge to the desired drilling depth.
6. Tighten the screw at the depth gauge.

5.1.3 Fitting/removing the accessory tool

CAUTION

Risk of injury! The accessory tool gets hot during use.

- ▶ Wear protective gloves when changing the accessory tool.
- ▶ Do not place the hot accessory tool on readily flammable materials.

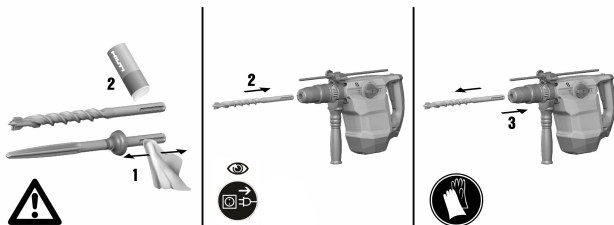

1. Apply a little grease to the connection end of the accessory tool.
2. Push the accessory tool into the chuck as far as it will go (until it engages).
 - ↳ The product is ready for use.
3. Pull the chuck back as far as it will go and remove the accessory tool.

Use only the recommended grease supplied by **Hilti**. Use of unsuitable grease may cause damage to the product.

5.2 Types of work

ATTENTION

Risk of damage by incorrect handling!

- ▶ Do not operate the switches for direction of rotation and/or function selection during operation.

Observe the safety instructions and warnings in this documentation and on the product.

5.2.1 Drilling with hammering action (hammer drilling)

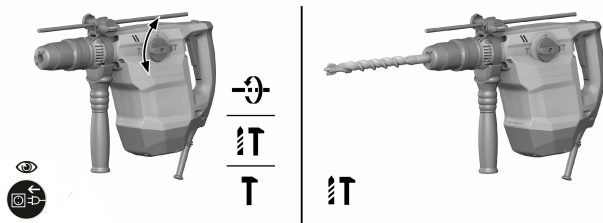

1. Set the function selector switch to the “Hammer drilling” position .
2. Press the drill bit against the work surface.
3. Press the control switch.
 - ↳ The product starts.

5.3 Chisel positioning



CAUTION

Risk of injury! Loss of control over the chisel direction.

- ▶ Do not operate the tool when the selector switch is set to “Chisel positioning”. Turn the function selector switch until it engages in the “Chiseling” position.

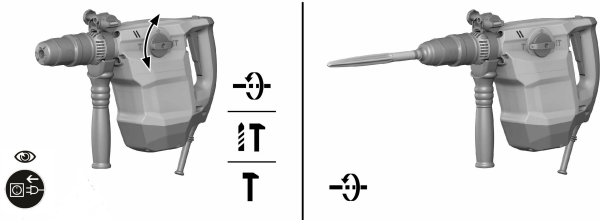
The chisel can be adjusted to 24 different positions (in 15° increments). This ensures that flat chisels and shaped chisels can always be set to the optimum working position.



1. Set the function selector switch to the “Chisel positioning” position .
2. Rotate the chisel to the desired position.
3. Turn the function selector switch until it engages in the “Chiseling”  position.
 - ↳ The product is ready for use.

5.3.1 Chiseling

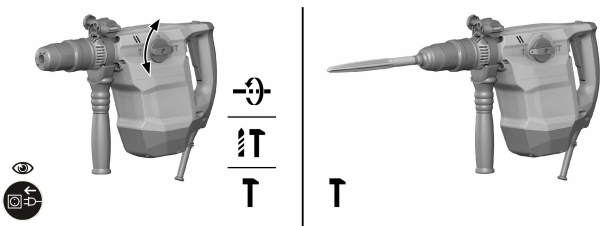

- ▶ Set the function selector switch to the “Chiseling” position .

5.3.2 Switching sustained operation on and off



When chiseling, the on/off switch can be locked in the “on” position.

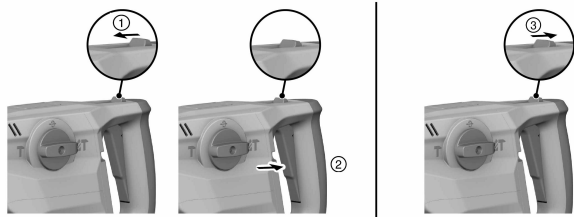

1. Push the lockbutton for continuous operation forward.
2. Press the on/off switch as far as it will go.
 - The product then runs in sustained operating mode.
3. Push the lockbutton for continuous operation back.
 - The product switches off.

6 Detachable supply cord

6.1 Connecting the detachable supply cord

⚠ CAUTION

Risk of injury! Due to leakage current as a result of dirty contacts.

- ▶ Connect the detachable electric connector to the electric tool only when it is clean and dry and when the supply cord is unplugged from the power outlet.

1. Push the keyed, detachable electric plug connector into the socket as far as it will go, until it is heard to engage.
2. Plug the supply cord into the power outlet.

6.2 Disconnecting the detachable supply cord

1. Unplug the supply cord from the power outlet.
2. Press the release button and pull the keyed, detachable electric plug connector out of the socket.
3. Pull the supply cord connector out of the power tool.

7 Care and maintenance

⚠ WARNING

Electric shock hazard! Attempting care and maintenance with the supply cord connected to a power outlet can lead to severe injury and burns.

- ▶ Always unplug the supply cord before carrying out care and maintenance tasks.

Care

- Carefully remove any dirt that may be adhering to parts.
- Clean the air vents carefully with a dry brush.
- Use only a slightly damp cloth to clean the casing. Do not use cleaning agents containing silicone as these may attack the plastic parts.

Maintenance

WARNING

Danger of electric shock! Improper repairs to electrical components may lead to serious injuries including burns.

► Repairs to the electrical section of the tool or appliance may be carried out only by trained electrical specialists.

- Check all visible parts and controls for signs of damage at regular intervals and make sure that they all function correctly.
- Do not operate the product if signs of damage are found or if parts malfunction. Have it repaired immediately by **Hilti Service**.
- After cleaning and maintenance, fit all guards or protective devices and check that they function correctly.

 To help ensure safe and reliable operation, use only genuine Hilti spare parts and consumables. Spare parts, consumables and accessories approved by Hilti for use with the product can be found at your local **Hilti Store** or online at: www.hilti.group.

8 Transport and storage

- Do not transport electric tools with accessory tools fitted.
- Always unplug the supply cord before storing an electric tool or appliance.
- Store tools and appliances in a dry place where they cannot be accessed by children or unauthorized persons.
- Check electric tools or appliances for damage after long periods of transport or storage.

9 Troubleshooting

If the trouble you are experiencing is not listed in this table or you are unable to remedy the problem by yourself, please contact **Hilti Service**.

9.1 Troubleshooting

Trouble or fault	Possible cause	Action to be taken
The power tool doesn't start.	Interruption in the electric supply.	► Plug in another electric tool or appliance and check whether it works.

Trouble or fault	Possible cause	Action to be taken
The power tool doesn't start.	The electronic restart interlock is activated after an interruption in the electric supply.	▶ Switch the power tool off and then on again.
No hammering action.	The power tool is too cold.	▶ Bring the tip of the drill bit into contact with the working surface, switch the rotary hammer on and allow it to run. If necessary, repeat the procedure until the hammering mechanism begins to operate.
The combihammer doesn't achieve full power.	The gauge (cross section) of the extension cord conductors is inadequate.	▶ Use an extension cord with an adequate conductor cross section.
	The voltage provided by the electric supply is too low.	▶ Connect the combihammer to a different electric supply.
The drill bit doesn't rotate.	The function selector switch is not engaged or is in the T "Chiseling" or ↺ "Chisel adjustment" position.	▶ Set the function selector switch to the "Hammer drilling" position T .
The drill bit can't be released.	The chuck is not pulled back fully.	▶ Pull the chuck back as far as it will go and remove the accessory tool.
	The side handle is not fitted correctly.	▶ Release the side handle and refit it correctly so that the clamping band and side handle engage in the recess.
The service indicator lights after changing the carbon brushes.	The contact surfaces are not yet run in.	▶ Run in the carbon brushes by allowing the power tool to run under no load for at least 1 minute without interruption.

10 Disposal

 Most of the materials from which **Hilti** tools and appliances are manufactured can be recycled. The materials must be correctly separated before they can be recycled. In many countries, your old tools, machines or appliances can be returned to **Hilti** for recycling. Ask **Hilti** Service or your Hilti representative for further information.



- ▶ Do not dispose of power tools, electronic equipment or batteries as household waste!
-

11 Manufacturer's warranty

- ▶ Please contact your local **Hilti** representative if you have questions about the warranty conditions.

This Product is Certified
Ce produit est homologué
Producto homologado por
Este produto está registrado





Hilti Corporation
LI-9494 Schaan
Tel.:+423 234 21 11
Fax:+423 234 29 65
www.hilti.com



2164701



Hilti Connect