



SETTING THE STANDARD FOR PERFORMANCE AND RELIABILITY

HIT-RE 100
Adhesive Anchor System





ADHESIVE ANCHORING SYSTEM

HIT-RE 100



The new Hilti HIT-RE 100 adhesive anchoring system is the latest addition to the slow cure adhesive anchor portfolio and designed for solid performance in a wide range of applications. Designed to utilize the existing Hilti dispenser platform and ICC-ES approved for cracked and uncracked concrete, this anchor is the perfect complement to the portfolio for day to day jobsite needs.



PERFORMANCE

- ICC approved for cracked and uncracked concrete
- Complete anchor system available, including HIT-V and HAS-E
- Easy and accurate dispensing with battery dispenser

RELIABILITY

- Automatic hole cleaning with SafeSet™ hollow drill bit technology
- Tested with wide range of rod diameters and embedments



Hilti Adhesive Anchors — every job, every application.

RE 100 SAFEset

RE 100

APPLICATIONS AND ADVANTAGES

- Anchoring light structural steel connections (e.g. steel columns, beams)
- Anchoring secondary steel elements
- Rebar doweling and connecting secondary post-installed rebar
- Substituting misplaced or missing rebar
- ICC approved for cracked and un-cracked concrete
- Tested with a wide range of rod diameters and embedments
- Complete anchor system available, including HAS-E, HAS-B, and HAS-R threaded rods
- Easier and more accurate dispensing with battery dispenser
- Can be used in a variety of hole conditions such as water-filled holes and underwater



Technical data

Product	high strength two-part epoxy
Base material temperature	41° F to 104° F (5° C to 40° C)
Diameter range	3/8" to 1-1/4"
Listings/Approvals	<ul style="list-style-type: none"> • ICC-ES (International Code Council) – ESR-3829 for cracked and un-cracked concrete including LABC and FBC supplements
Package volume	<ul style="list-style-type: none"> • Volume of HIT-RE 100 11.1 fl oz/330 ml foil pack is 20.1 in³ • Volume of HIT-RE 100 16.9 fl oz/500 ml foil pack is 30.5 in³ • Volume of HIT-RE 100 47.3 fl oz/1400 ml foil pack is 85.4 in³

Working/Full Cure Time Table (Approximate)

Base Material Temperature		t _{work}	t _{cure}
° F	° C		
41	5	2-1/2 h	72 h
50	10	2 h	48 h
59	15	1-1/2 h	24 h
68	20	30 min	12 h
86	30	20 min	8 h
104	40	12 min	4 h

ORDER INFORMATION

Description	Qty of foil packs	Item number
Epoxy adhesive HIT-RE 100 (11.1oz/330ml)	1	2123381
Epoxy adhesive HIT-RE 100 master carton (11.1oz/330ml)	25	3537468
Epoxy adhesive HIT-RE 100 master carton (11.1oz/330ml) + HDM 500	25	3537469
Epoxy adhesive HIT-RE 100 master carton (16.9oz/500ml)	20	2123384
Epoxy adhesive HIT-RE 100 master carton (16.9oz/500ml) + HDM 500	20	3537470
(2) Epoxy adhesive HIT-RE 100 master cartons (16.9oz/500ml) + HDE 500 kit	40	3537471
(5) Epoxy adhesive HIT-RE 100 master cartons (16.9oz/500ml) + HDE 500 kit	100	3537472
Epoxy adhesive HIT-RE 100 (47.3 fl oz/1400 ml)	4	2123387*
Epoxy adhesive HIT-RE 100 (47.3 fl oz/1400 ml) pallet + P8000 pneumatic dispenser	64	3537473*

* Available by special order. Call Hilti for details.





ACCESSORIES

Description	Item number
Manual dispenser HDM 500	3498241
Compact cordless dispenser HDE 500 + (2) B 18/2.6 Li-ion battery packs + C 4/36-90 100-127V charger + HIT-CB 500 black cartridge + HIT-CR 500 red cartridge + small tool bag	3496604
Industrial cordless dispenser HDE 500 + (2) B 18/5.2 Li-ion battery packs + C 4/36-90 100a-127V charger + HIT-CB 500 black cartridge + HIT-CR 500 red cartridge + small tool bag	3540270
Pneumatic dispenser P8000	373959

HIT-RE 100 ADHESIVE ANCHORING SYSTEM

Product description

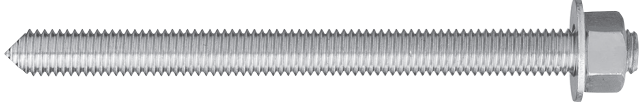
Element Type	Features and Benefits
 <p>HIT-RE 100</p>	<ul style="list-style-type: none"> • Seismic qualified with ICC-ES Acceptance Criteria AC308 and ACI 355.4 • Use in water-filled holes and underwater up to 165 ft (50 m) • Mixing nozzle provides proper mixing, helps eliminate measuring errors and minimizing waste
 <p>Rebar</p>	<ul style="list-style-type: none"> • Meets requirements of ASTM C881-14, Type I, II, IV, and V Grade 3, Class A, B, C
 <p>Hilti HAS Threaded Rod</p>	<ul style="list-style-type: none"> • Meets requirements of AASHTO specification M235, Type I, II, IV, and V Grade 3, Class A, B, C

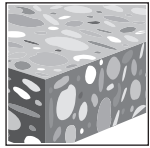

Uncracked concrete

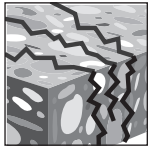

Cracked concrete

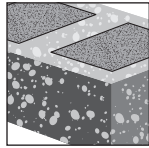

Grout-filled concrete masonry

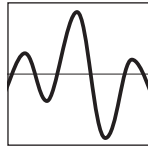

Seismic Design Categories A-F



Hollow Drill Bit



Profis Anchor design software

Listings/Approvals	
ICC-ES (International Code Council)	ESR-3829
NSF/ANSI Standard 61	Certification for use of HIT-RE 100 in potable water
City of Los Angeles	City of Los Angeles 2017 LABC Supplement (within ESR-3829)
Independent Code Evaluation	IBC®/IRC® 2018 (ICC-ES AC308/ACI 355.4) IBC®/IRC® 2015 (ICC-ES AC308/ACI 355.4) IBC®/IRC® 2012 (ICC-ES AC308/ACI 355.4) IBC®/IRC® 2009 (ICC-ES AC308) LEED®: Credit 4.1-Low Emitting Materials



DESIGN DATA IN CONCRETE PER ACI 318





ACI 318-14 Chapter 17 design

The technical data contained in this section are Hilti Simplified Design Tables. The load values were developed using the Strength Design parameters developed through testing per ACI 355.4 and the equations within ACI 318-14 Chapter 17. For a detailed explanation of the Hilti Simplified Design Tables, refer to of the Hilti North American Product Technical Guide, Volume 2: Anchor Fastening Technical Guide, Edition 19 (2019 PTG).

For additional information or technical assistance, contact Hilti at 800-879-5000 (US) or 800-363-4459 (CA)

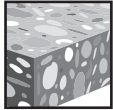
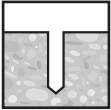
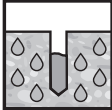
Hilti HIT-RE 100 Adhesive with Deformed Reinforcing Bars (Rebar)

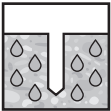

Permissible concrete conditions		Uncracked concrete		Dry Concrete		Water-filled holes	Permissible Drilling Method		Hammer drilling with carbide tipped drill bit
		Cracked concrete		Water-saturated concrete		Submerged (underwater)			Hilti TE-CD or TE-YD Hollow Drill Bit

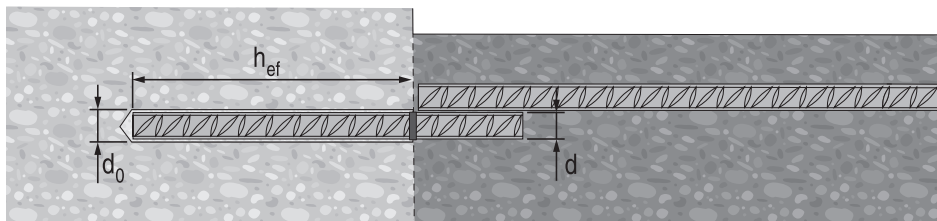

Table 1 — Specifications for rebar installed with HIT-RE 100 adhesive

Setting information	Symbol	Units	Rebar Size								
			3	4	5	6	7	8	9	10	
Nominal bit diameter	d_o	in.	1/2	5/8	3/4	7/8	1	1-1/8	1-3/8	1-1/2	
Effective Embedment	minimum	$h_{ef,min}$	in.	2-3/8	2-3/4	3-1/8	3-1/2	3-1/8	4	4-1/2	5
		(mm)	(60)	(70)	(79)	(89)	(79)	(102)	(114)	(127)	
Effective Embedment	maximum	$h_{ef,max}$	in.	7-1/2	10	12-1/2	15	17-1/2	20	22-1/2	25
		(mm)	(191)	(254)	(318)	(381)	(445)	(508)	(572)	(635)	
Minimum Concrete Thickness	h_{min}	in.	$h_{ef} + 1-1/4$			$h_{ef} + 2d_o$					
		(mm)	$(h_{ef} + 30)$								
Minimum edge distance ¹	c_{min}	in.	1-7/8	2-1/2	3-1/8	3-3/4	4-3/8	5	5-5/8	6-1/4	
		(mm)	(48)	(64)	(79)	(95)	(111)	(127)	(143)	(159)	
Minimum anchor spacing	s_{min}	in.	1-7/8	2-1/2	3-1/8	3-3/4	4-3/8	5	5-5/8	6-1/4	
		(mm)	(48)	(64)	(79)	(95)	(111)	(127)	(143)	(159)	

¹ Edge distance of 1-3/4-inch (44mm) is permitted provided the rebar remains un-torqued.

Note: The installation specifications in table 1 above and the data in tables 2 through 20 pertain to the use of Hilti HIT-RE 100 with rebar designed as a post-installed anchor using the provisions of ACI 318-14 Chapter 17. For the use of Hilti HIT-RE 100 with rebar for typical development calculations according to ACI 318-14 Chapter 25 (formerly ACI 318-11 Chapter 12), refer to section 3.1.14 (2019 PTG) for the design method and tables 57 through 66 at the end of this document.

Table 2 — Hilti HIT-RE 100 adhesive design strength with concrete / bond failure for US rebar in uncracked concrete ^{1,2,3,4,5,6,7,8,9,10}

Rebar Size	Effective Embedment Depth in. (mm)	Tension — ϕN_n				Shear — ϕV_n			
		$f'_c = 2500$ psi (17.2 MPa) lb (kN)	$f'_c = 3000$ psi (20.7 MPa) lb (kN)	$f'_c = 4000$ psi (27.6 MPa) lb (kN)	$f'_c = 6000$ psi (41.4 MPa) lb (kN)	$f'_c = 2500$ psi (17.2 MPa) lb (kN)	$f'_c = 3000$ psi (20.7 MPa) lb (kN)	$f'_c = 4000$ psi (27.6 MPa) lb (kN)	$f'_c = 6000$ psi (41.4 MPa) lb (kN)
#3	3-3/8 (86)	2,780 (12.4)	2,835 (12.6)	2,915 (13.0)	3,035 (13.5)	7,080 (31.5)	7,210 (32.1)	7,420 (33.0)	7,730 (34.4)
	4-1/2 (114)	3,710 (16.5)	3,775 (16.8)	3,885 (17.3)	4,050 (18.0)	9,440 (42.0)	9,615 (42.8)	9,895 (44.0)	10,305 (45.8)
	7-1/2 (191)	6,180 (27.5)	6,295 (28.0)	6,480 (28.8)	6,745 (30.0)	15,735 (70.0)	16,025 (71.3)	16,490 (73.4)	17,175 (76.4)
#4	4-1/2 (114)	4,885 (21.7)	4,975 (22.1)	5,120 (22.8)	5,330 (23.7)	12,430 (55.3)	12,660 (56.3)	13,030 (58.0)	13,565 (60.3)
	6 (152)	6,510 (29.0)	6,630 (29.5)	6,825 (30.4)	7,105 (31.6)	16,575 (73.7)	16,875 (75.1)	17,370 (77.3)	18,090 (80.5)
	10 (254)	10,850 (48.3)	11,050 (49.2)	11,375 (50.6)	11,845 (52.7)	27,620 (122.9)	28,130 (125.1)	28,950 (128.8)	30,150 (134.1)
#5	5-5/8 (143)	7,315 (32.5)	7,450 (33.1)	7,665 (34.1)	7,985 (35.5)	18,615 (82.8)	18,960 (84.3)	19,515 (86.8)	20,320 (90.4)
	7-1/2 (191)	9,750 (43.4)	9,930 (44.2)	10,220 (45.5)	10,645 (47.4)	24,825 (110.4)	25,280 (112.5)	26,015 (115.7)	27,095 (120.5)
	12-1/2 (318)	16,255 (72.3)	16,550 (73.6)	17,035 (75.8)	17,740 (78.9)	41,370 (184.0)	42,130 (187.4)	43,360 (192.9)	45,155 (200.9)
#6	6-3/4 (171)	10,180 (45.3)	10,370 (46.1)	10,670 (47.5)	11,115 (49.4)	25,920 (115.3)	26,395 (117.4)	27,165 (120.8)	28,290 (125.8)
	9 (229)	13,575 (60.4)	13,825 (61.5)	14,230 (63.3)	14,820 (65.9)	34,555 (153.7)	35,195 (156.6)	36,220 (161.1)	37,720 (167.8)
	15 (381)	22,625 (100.6)	23,045 (102.5)	23,715 (105.5)	24,695 (109.8)	57,595 (256.2)	58,655 (260.9)	60,365 (268.5)	62,865 (279.6)
#7	7-7/8 (200)	13,385 (59.5)	13,630 (60.6)	14,025 (62.4)	14,605 (65.0)	34,065 (151.5)	34,690 (154.3)	35,705 (158.8)	37,180 (165.4)
	10-1/2 (267)	17,845 (79.4)	18,170 (80.8)	18,700 (83.2)	19,475 (86.6)	45,420 (202.0)	46,255 (205.8)	47,605 (211.8)	49,575 (220.5)
	17-1/2 (445)	29,740 (132.3)	30,285 (134.7)	31,170 (138.7)	32,460 (144.4)	75,700 (336.7)	77,090 (342.9)	79,340 (352.9)	82,625 (367.5)
#8	9 (229)	16,980 (75.5)	17,295 (76.9)	17,800 (79.2)	18,535 (82.4)	43,225 (192.3)	44,020 (195.8)	45,305 (201.5)	47,180 (209.9)
	12 (305)	22,640 (100.7)	23,060 (102.6)	23,730 (105.6)	24,715 (109.9)	57,635 (256.4)	58,695 (261.1)	60,410 (268.7)	62,910 (279.8)
	20 (508)	37,735 (167.9)	38,430 (170.9)	39,555 (175.9)	41,190 (183.2)	96,055 (427.3)	97,825 (435.1)	100,680 (447.8)	104,845 (466.4)
#9	10-1/8 (257)	21,020 (93.5)	21,405 (95.2)	22,030 (98.0)	22,945 (102.1)	53,505 (238.0)	54,490 (242.4)	56,080 (249.5)	58,400 (259.8)
	13-1/2 (343)	28,025 (124.7)	28,540 (127.0)	29,375 (130.7)	30,590 (136.1)	71,340 (317.3)	72,655 (323.2)	74,775 (332.6)	77,870 (346.4)
	22-1/2 (572)	46,710 (207.8)	47,570 (211.6)	48,960 (217.8)	50,985 (226.8)	118,900 (528.9)	121,090 (538.6)	124,620 (554.3)	129,780 (577.3)
#10	11-1/4 (286)	25,465 (113.3)	25,935 (115.4)	26,690 (118.7)	27,795 (123.6)	63,395 (282.0)	66,010 (293.6)	67,940 (302.2)	70,750 (314.7)
	15 (381)	33,955 (151.0)	34,575 (153.8)	35,585 (158.3)	37,060 (164.9)	86,425 (384.4)	88,015 (391.5)	90,585 (402.9)	94,335 (419.6)
	25 (635)	56,590 (251.7)	57,630 (256.3)	59,310 (263.8)	61,765 (274.7)	144,040 (640.7)	146,690 (652.5)	150,975 (671.6)	157,220 (699.3)

1 See Section 3.1.8 (2019 PTG) for explanation on development of load values.
2 See Section 3.1.8.6 (2019 PTG) to convert design strength value to ASD value.
3 Linear interpolation between embedment depths and concrete compressive strengths is not permitted.
4 Apply spacing, edge distance, and concrete thickness factors in tables 5-20 as necessary. Compare to the steel values in table 4. The lesser of the values is to be used for the design.
5 Values are for the following temperature range: maximum short term temperature = 130°F (55°C), maximum long term temperature = 110°F (43°C). Short term elevated concrete temperatures are those that occur over brief intervals, e.g., as a result of diurnal cycling. Long term concrete temperatures are roughly constant over significant periods of time.
6 Tabular values are for dry concrete conditions. For water saturated concrete, water-filled drilled holes, or submerged (underwater) applications multiply design strength by 0.61.
7 Tabular values are for short term loads only. For sustained loads including overhead use, see Section 3.1.8.8 (2019 PTG).
8 Tabular values are for normal-weight concrete only. For lightweight concrete multiply design strength by λ_s as follows:
For sand-lightweight, $\lambda_s = 0.51$. For all-lightweight, $\lambda_s = 0.45$.
9 Tabular values are for holes drilled in concrete with carbide tipped hammer drill bit. Diamond core drilling is not permitted.
10 Tabular values are for static loads only. Seismic design is not permitted for uncracked concrete.

Table 3 — Hilti HIT-RE 100 adhesive design strength with concrete / bond failure for US rebar in cracked concrete ^{1,2,3,4,5,6,7,8,9,10}

Rebar Size	Effective Embedment Depth in. (mm)	Tension — ϕN_n				Shear — ϕV_n			
		$f'_c = 2500$ psi (17.2 MPa) lb (kN)	$f'_c = 3000$ psi (20.7 MPa) lb (kN)	$f'_c = 4000$ psi (27.6 MPa) lb (kN)	$f'_c = 6000$ psi (41.4 MPa) lb (kN)	$f'_c = 2500$ psi (17.2 MPa) lb (kN)	$f'_c = 3000$ psi (20.7 MPa) lb (kN)	$f'_c = 4000$ psi (27.6 MPa) lb (kN)	$f'_c = 6000$ psi (41.4 MPa) lb (kN)
#3	3-3/8 (86)	1,040 (4.6)	1,060 (4.7)	1,090 (4.8)	1,135 (5.0)	2,650 (11.8)	2,700 (12.0)	2,775 (12.3)	2,890 (12.9)
	4-1/2 (114)	1,390 (6.2)	1,415 (6.3)	1,455 (6.5)	1,515 (6.7)	3,535 (15.7)	3,600 (16.0)	3,705 (16.5)	3,855 (17.1)
	7-1/2 (191)	2,315 (10.3)	2,355 (10.5)	2,425 (10.8)	2,525 (11.2)	5,890 (26.2)	5,995 (26.7)	6,170 (27.4)	6,425 (28.6)
#4	4-1/2 (114)	1,850 (8.2)	1,885 (8.4)	1,940 (8.6)	2,020 (9.0)	4,710 (21.0)	4,795 (21.3)	4,935 (22.0)	5,140 (22.9)
	6 (152)	2,465 (11.0)	2,515 (11.2)	2,585 (11.5)	2,695 (12.0)	6,280 (27.9)	6,395 (28.4)	6,585 (29.3)	6,855 (30.5)
	10 (254)	4,110 (18.3)	4,190 (18.6)	4,310 (19.2)	4,490 (20.0)	10,470 (46.6)	10,660 (47.4)	10,970 (48.8)	11,425 (50.8)
#5	5-5/8 (143)	2,890 (12.9)	2,945 (13.1)	3,030 (13.5)	3,155 (14.0)	7,360 (32.7)	7,495 (33.3)	7,715 (34.3)	8,035 (35.7)
	7-1/2 (191)	3,855 (17.1)	3,925 (17.5)	4,040 (18.0)	4,210 (18.7)	9,815 (43.7)	9,995 (44.5)	10,285 (45.7)	10,710 (47.6)
	12-1/2 (318)	6,425 (28.6)	6,545 (29.1)	6,735 (30.0)	7,015 (31.2)	16,355 (72.8)	16,655 (74.1)	17,145 (76.3)	17,850 (79.4)
#6	6-3/4 (171)	4,165 (18.5)	4,240 (18.9)	4,365 (19.4)	4,545 (20.2)	10,600 (47.2)	10,795 (48.0)	11,110 (49.4)	11,570 (51.5)
	9 (229)	5,550 (24.7)	5,655 (25.2)	5,820 (25.9)	6,060 (27.0)	14,130 (62.9)	14,390 (64.0)	14,810 (65.9)	15,425 (68.6)
	15 (381)	9,255 (41.2)	9,425 (41.9)	9,700 (43.1)	10,100 (44.9)	23,555 (104.8)	23,985 (106.7)	24,685 (109.8)	25,705 (114.3)
#7	7-7/8 (200)	5,665 (25.2)	5,770 (25.7)	5,940 (26.4)	6,185 (27.5)	14,425 (64.2)	14,690 (65.3)	15,120 (67.3)	15,745 (70.0)
	10-1/2 (267)	7,555 (33.6)	7,695 (34.2)	7,920 (35.2)	8,250 (36.7)	19,235 (85.6)	19,590 (87.1)	20,160 (89.7)	20,995 (93.4)
	17-1/2 (445)	12,595 (56.0)	12,825 (57.0)	13,200 (58.7)	13,745 (61.1)	32,060 (142.6)	32,645 (145.2)	33,600 (149.5)	34,990 (155.6)
#8	9 (229)	7,030 (31.3)	7,160 (31.8)	7,365 (32.8)	7,670 (34.1)	17,890 (79.6)	18,220 (81.0)	18,755 (83.4)	19,530 (86.9)
	12 (305)	9,370 (41.7)	9,545 (42.5)	9,825 (43.7)	10,230 (45.5)	23,855 (106.1)	24,295 (108.1)	25,005 (111.2)	26,040 (115.8)
	20 (508)	15,620 (69.5)	15,905 (70.7)	16,370 (72.8)	17,050 (75.8)	39,760 (176.9)	40,490 (180.1)	41,675 (185.4)	43,400 (193.1)
#9	10-1/8 (257)	8,425 (37.5)	8,580 (38.2)	8,830 (39.3)	9,195 (40.9)	21,440 (95.4)	21,835 (97.1)	22,475 (100.0)	23,405 (104.1)
	13-1/2 (343)	11,230 (50.0)	11,440 (50.9)	11,770 (52.4)	12,260 (54.5)	28,590 (127.2)	29,115 (129.5)	29,965 (133.3)	31,205 (138.8)
	22-1/2 (572)	18,720 (83.3)	19,065 (84.8)	19,620 (87.3)	20,430 (90.9)	47,650 (212.0)	48,525 (215.8)	49,940 (222.1)	52,010 (231.4)
#10	11-1/4 (286)	9,915 (44.1)	10,095 (44.9)	10,390 (46.2)	10,820 (48.1)	25,235 (112.3)	25,700 (114.3)	26,450 (117.7)	27,545 (122.5)
	15 (381)	13,220 (58.8)	13,460 (59.9)	13,855 (61.6)	14,430 (64.2)	33,645 (149.7)	34,265 (152.4)	35,265 (156.9)	36,725 (163.4)
	25 (635)	22,030 (98.0)	22,435 (99.8)	23,090 (102.7)	24,045 (107.0)	56,075 (249.4)	57,110 (254.0)	58,775 (261.4)	61,210 (272.3)

- 1 See Section 3.1.8 (2019 PTG) for explanation on development of load values.
- 2 See Section 3.1.8.6 (2019 PTG) to convert design strength value to ASD value.
- 3 Linear interpolation between embedment depths and concrete compressive strengths is not permitted.
- 4 Apply spacing, edge distance, and concrete thickness factors in tables 5-20 as necessary. Compare to the steel values in table 4. The lesser of the values is to be used for the design.
- 5 Values are for the following temperature range: maximum short term temperature = 130°F (55°C), maximum long term temperature = 110°F (43°C). Short term elevated concrete temperatures are those that occur over brief intervals, e.g., as a result of diurnal cycling. Long term concrete temperatures are roughly constant over significant periods of time.
- 6 Tabular values are for dry concrete conditions. For water saturated concrete, water-filled drilled holes, or submerged (underwater) applications multiply design strength by 0.60.
- 7 Tabular values are for short term loads only. For sustained loads including overhead use, see Section 3.1.8.8 (2019 PTG).
- 8 Tabular values are for normal-weight concrete only. For lightweight concrete multiply design strength by λ_a as follows:
For sand-lightweight, $\lambda_a = 0.51$. For all-lightweight, $\lambda_a = 0.45$.
- 9 Tabular values are for holes drilled in concrete with carbide tipped hammer drill bit. Diamond core drilling is not permitted.
- 10 Tabular values are for static loads only. For seismic loads, multiply cracked concrete tabular values in tension and shear by $\alpha_{\text{seis}} = 0.675$. See section 3.1.8.7 (2019 PTG) for additional information on seismic applications.

Table 4 — Steel design strength for US rebar ¹

Rebar Size	ASTM A 615 Grade 40 ²			ASTM A 615 Grade 60 ²			ASTM A 706 Grade 60 ²		
	Tensile ³ ϕN_{sa} lb (kN)	Shear ⁴ ϕV_{sa} lb (kN)	Seismic Shear ⁵ $\phi V_{sa,eq}$ lb (kN)	Tensile ³ ϕN_{sa} lb (kN)	Shear ⁴ ϕV_{sa} lb (kN)	Seismic Shear ⁵ $\phi V_{sa,eq}$ lb (kN)	Tensile ³ ϕN_{sa} lb (kN)	Shear ⁴ ϕV_{sa} lb (kN)	Seismic Shear ⁵ $\phi V_{sa,eq}$ lb (kN)
#3	4,290 (19.1)	2,375 (10.6)	1,665 (7.4)	6,435 (28.6)	3,565 (15.9)	2,495 (11.1)	6,600 (29.4)	3,430 (15.3)	2,400 (10.7)
#4	7,800 (34.7)	4,320 (19.2)	3,025 (13.5)	11,700 (52.0)	6,480 (28.8)	4,535 (20.2)	12,000 (53.4)	6,240 (27.8)	4,370 (19.4)
#5	12,090 (53.8)	6,695 (29.8)	4,685 (20.8)	18,135 (80.7)	10,045 (44.7)	7,030 (31.3)	18,600 (82.7)	9,670 (43.0)	6,770 (30.1)
#6	17,160 (76.3)	9,505 (42.3)	6,655 (29.6)	25,740 (114.5)	14,255 (63.4)	9,980 (44.4)	26,400 (117.4)	13,730 (61.1)	9,610 (42.7)
#7	23,400 (104.1)	12,960 (57.6)	9,070 (40.3)	35,100 (156.1)	19,440 (86.5)	13,610 (60.5)	36,000 (160.1)	18,720 (83.3)	13,105 (58.3)
#8	30,810 (137.0)	17,065 (75.9)	11,945 (53.1)	46,215 (205.6)	25,595 (113.9)	17,915 (79.7)	47,400 (210.8)	24,650 (109.6)	17,255 (76.8)
#9	39,000 (173.5)	21,600 (96.1)	15,120 (67.3)	58,500 (260.2)	32,400 (144.1)	22,680 (100.9)	60,000 (266.9)	31,200 (138.8)	21,840 (97.1)
#10	49,530 (220.3)	27,430 (122.0)	19,200 (85.4)	74,295 (330.5)	41,150 (183.0)	28,805 (128.1)	76,200 (339.0)	39,625 (176.3)	27,740 (123.4)

¹ See Section 3.1.8.6 (2019 PTG) to convert design strength value to ASD value.

² ASTM A706 Grade 60 rebar are considered ductile steel elements. ASTM A 615 Grade 40 and 60 rebar are considered brittle steel elements.

³ Tensile = $\phi A_{sa} f_{uta}$ as noted in ACI 318-14 Chapter 17

⁴ Shear = $\phi 0.60 A_{sa} f_{uta}$ as noted in ACI 318-14 Chapter 17

⁵ Seismic Shear = $\alpha_{v,seis} \phi V_{sa}$: Reduction for seismic shear only.

Table 5 — Load adjustment factors for #3 rebar in uncracked concrete ^{1,2,3}

#3 Uncracked Concrete	Spacing Factor in Tension			Edge Distance Factor in Tension			Spacing Factor in Shear ⁴			Edge Distance in Shear						Concrete Thickness Factor in Shear ⁵			
	f_{AN}			f_{RN}			f_{AV}			⊥ Toward Edge f_{RV}			∥ To Edge f_{RV}			f_{HV}			
	Embedment h_{ef} in (mm)	3-3/8 (86)	4-1/2 (114)	7-1/2 (191)	3-3/8 (86)	4-1/2 (114)	7-1/2 (191)	3-3/8 (86)	4-1/2 (114)	7-1/2 (191)	3-3/8 (86)	4-1/2 (114)	7-1/2 (191)	3-3/8 (86)	4-1/2 (114)	7-1/2 (191)	3-3/8 (86)	4-1/2 (114)	7-1/2 (191)
Spacing (s) / Edge Distance (c_e) / Concrete Thickness (h) — in (mm)	1-3/4 (44)	n/a	n/a	n/a	0.32	0.23	0.13	n/a	n/a	n/a	0.10	0.08	0.05	0.21	0.16	0.09	n/a	n/a	n/a
	1-7/8 (48)	0.59	0.57	0.54	0.33	0.24	0.14	0.54	0.53	0.52	0.12	0.09	0.05	0.23	0.17	0.10	n/a	n/a	n/a
	2 (51)	0.60	0.57	0.54	0.34	0.25	0.14	0.54	0.53	0.52	0.13	0.10	0.06	0.25	0.19	0.11	n/a	n/a	n/a
	3 (76)	0.65	0.61	0.57	0.42	0.31	0.18	0.56	0.55	0.54	0.23	0.18	0.11	0.42	0.31	0.18	n/a	n/a	n/a
	4 (102)	0.70	0.65	0.59	0.52	0.38	0.22	0.58	0.57	0.55	0.36	0.27	0.16	0.52	0.38	0.22	n/a	n/a	n/a
	4-5/8 (117)	0.73	0.67	0.60	0.60	0.43	0.25	0.60	0.58	0.56	0.45	0.34	0.20	0.60	0.43	0.25	0.62	n/a	n/a
	5 (127)	0.75	0.69	0.61	0.64	0.47	0.27	0.61	0.59	0.56	0.50	0.38	0.23	0.64	0.47	0.27	0.65	n/a	n/a
	5-3/4 (146)	0.78	0.71	0.63	0.74	0.54	0.31	0.62	0.60	0.57	0.62	0.46	0.28	0.74	0.54	0.31	0.70	0.63	n/a
	6 (152)	0.80	0.72	0.63	0.77	0.56	0.33	0.63	0.60	0.57	0.66	0.50	0.30	0.77	0.56	0.33	0.71	0.65	n/a
	7 (178)	0.85	0.76	0.66	0.90	0.66	0.38	0.65	0.62	0.59	0.83	0.62	0.37	0.90	0.66	0.38	0.77	0.70	n/a
	8 (203)	0.90	0.80	0.68	1.00	0.75	0.43	0.67	0.64	0.60	1.00	0.76	0.46	1.00	0.75	0.43	0.82	0.75	n/a
	8-3/4 (222)	0.93	0.82	0.69		0.82	0.48	0.68	0.65	0.61		0.87	0.52		0.82	0.48	0.86	0.78	0.66
	9 (229)	0.94	0.83	0.70		0.84	0.49	0.69	0.66	0.61		0.91	0.55		0.84	0.49	0.87	0.79	0.67
	10 (254)	0.99	0.87	0.72		0.94	0.54	0.71	0.67	0.62		1.00	0.64		0.94	0.54	0.92	0.83	0.70
	11 (279)	1.00	0.91	0.74		1.00	0.60	0.73	0.69	0.64			0.74		1.00	0.60	0.96	0.87	0.74
	12 (305)		0.94	0.77			0.65	0.75	0.71	0.65			0.84			0.65	1.00	0.91	0.77
	14 (356)		1.00	0.81			0.76	0.80	0.74	0.67			1.00			0.76		0.99	0.83
	16 (406)			0.86			0.87	0.84	0.78	0.70						0.87		1.00	0.89
	18 (457)			0.90			0.98	0.88	0.81	0.72						0.98			0.94
	24 (610)			1.00			1.00	1.00	0.92	0.80						1.00			1.00
30 (762)								1.00	0.87										
36 (914)									0.95										
>48 (1219)									1.00										

Table 6 — Load adjustment factors for #3 rebar in cracked concrete ^{1,2,3}

#3 Cracked Concrete	Spacing Factor in Tension			Edge Distance Factor in Tension			Spacing Factor in Shear ⁴			Edge Distance in Shear						Concrete Thickness Factor in Shear ⁵			
	f_{AN}			f_{RN}			f_{AV}			⊥ Toward Edge f_{RV}			∥ To Edge f_{RV}			f_{HV}			
	Embedment h_{ef} in (mm)	3-3/8 (86)	4-1/2 (114)	7-1/2 (191)	3-3/8 (86)	4-1/2 (114)	7-1/2 (191)	3-3/8 (86)	4-1/2 (114)	7-1/2 (191)	3-3/8 (86)	4-1/2 (114)	7-1/2 (191)	3-3/8 (86)	4-1/2 (114)	7-1/2 (191)	3-3/8 (86)	4-1/2 (114)	7-1/2 (191)
Spacing (s) / Edge Distance (c_e) / Concrete Thickness (h) — in (mm)	1-3/4 (44)	n/a	n/a	n/a	0.54	0.49	0.43	n/a	n/a	n/a	0.20	0.15	0.09	0.40	0.30	0.18	n/a	n/a	n/a
	1-7/8 (48)	0.59	0.57	0.54	0.56	0.50	0.44	0.56	0.55	0.54	0.22	0.17	0.10	0.44	0.33	0.20	n/a	n/a	n/a
	2 (51)	0.60	0.57	0.54	0.57	0.51	0.44	0.56	0.55	0.54	0.24	0.18	0.11	0.49	0.36	0.22	n/a	n/a	n/a
	3 (76)	0.65	0.61	0.57	0.70	0.60	0.49	0.60	0.58	0.56	0.45	0.33	0.20	0.70	0.60	0.40	n/a	n/a	n/a
	4 (102)	0.70	0.65	0.59	0.84	0.70	0.55	0.63	0.61	0.58	0.69	0.51	0.31	0.84	0.70	0.55	n/a	n/a	n/a
	4-5/8 (117)	0.73	0.67	0.60	0.93	0.76	0.58	0.65	0.62	0.59	0.85	0.64	0.38	0.93	0.76	0.58	0.77	n/a	n/a
	5 (127)	0.75	0.69	0.61	0.99	0.80	0.60	0.66	0.63	0.60	0.96	0.72	0.43	0.99	0.80	0.60	0.81	n/a	n/a
	5-3/4 (146)	0.78	0.71	0.63	1.00	0.88	0.64	0.69	0.65	0.61	1.00	0.89	0.53	1.00	0.88	0.64	0.86	0.78	n/a
	6 (152)	0.80	0.72	0.63		0.91	0.66	0.69	0.66	0.61		0.95	0.57		0.91	0.66	0.88	0.80	n/a
	7 (178)	0.85	0.76	0.66		1.00	0.72	0.73	0.69	0.63		1.00	0.72		1.00	0.72	0.95	0.87	n/a
	8 (203)	0.90	0.80	0.68			0.78	0.76	0.71	0.65			0.87			0.78	1.00	0.93	n/a
	8-3/4 (222)	0.93	0.82	0.69			0.83	0.78	0.73	0.67			1.00			0.83		0.97	0.82
	9 (229)	0.94	0.83	0.70			0.85	0.79	0.74	0.67						0.85		0.98	0.83
	10 (254)	0.99	0.87	0.72			0.91	0.82	0.77	0.69						0.91		1.00	0.87
	11 (279)	1.00	0.91	0.74			0.98	0.86	0.79	0.71						0.98			0.92
	12 (305)		0.94	0.77			1.00	0.89	0.82	0.73						1.00			0.96
	14 (356)		1.00	0.81				0.95	0.87	0.77									1.00
	16 (406)			0.86				1.00	0.93	0.80									
	18 (457)			0.90					0.98	0.84									
	24 (610)			1.00					1.00	0.96									
30 (762)									1.00										
36 (914)																			
>48 (1219)																			

Footnotes for Tables 5 and 6

- Linear interpolation not permitted
- Shaded area with reduced edge distance is permitted provided rebar has no installation torque.
- When combining multiple load adjustment factors (e.g. for a four-anchor pattern in a corner with thin concrete member) the design can become very conservative. To optimize the design, use Hilti PROFIS Anchor Design software or perform anchor calculation using design equations from ACI 318-14 Chapter 17.
- Spacing factor reduction in shear, f_{AV} , assumes an influence of a nearby edge. If no edge exists, then $f_{AV} = f_{AN}$.
- Concrete thickness reduction factor in shear, f_{HV} , assumes an influence of a nearby edge. If no edge exists, then $f_{HV} = 1.0$.

Table 7 — Load adjustment factors for #4 rebar in uncracked concrete^{1,2,3}

	#4 Uncracked Concrete	Spacing Factor in Tension f_{AN}			Edge Distance Factor in Tension f_{RN}			Spacing Factor in Shear ⁴ f_{AV}			Edge Distance in Shear						Concrete Thickness Factor in Shear ⁵ f_{HV}		
											⊥ Toward Edge f_{RV}			∥ To Edge f_{RV}					
		Embedment h_{ef} in (mm)	4-1/2 (114)	6 (152)	10 (254)	4-1/2 (114)	6 (152)	10 (254)	4-1/2 (114)	6 (152)	10 (254)	4-1/2 (114)	6 (152)	10 (254)	4-1/2 (114)	6 (152)	10 (254)	4-1/2 (114)	6 (152)
Spacing (s) / Edge Distance (c_e) / Concrete Thickness (h) — in (mm)	1-3/4 (44)	n/a	n/a	n/a	0.27	0.20	0.12	n/a	n/a	n/a	0.07	0.05	0.03	0.14	0.10	0.06	n/a	n/a	n/a
	2-1/2 (64)	0.59	0.57	0.54	0.32	0.23	0.14	0.54	0.53	0.52	0.12	0.09	0.05	0.23	0.18	0.11	n/a	n/a	n/a
	3 (76)	0.61	0.58	0.55	0.35	0.26	0.15	0.55	0.54	0.53	0.15	0.12	0.07	0.31	0.23	0.14	n/a	n/a	n/a
	4 (102)	0.65	0.61	0.57	0.41	0.30	0.18	0.56	0.55	0.54	0.24	0.18	0.11	0.41	0.30	0.18	n/a	n/a	n/a
	5 (127)	0.69	0.64	0.58	0.48	0.35	0.21	0.58	0.57	0.55	0.33	0.25	0.15	0.48	0.35	0.21	n/a	n/a	n/a
	5-3/4 (146)	0.71	0.66	0.60	0.54	0.40	0.23	0.59	0.58	0.55	0.41	0.31	0.18	0.54	0.40	0.23	0.61	n/a	n/a
	6 (152)	0.72	0.67	0.60	0.57	0.42	0.24	0.60	0.58	0.56	0.43	0.33	0.20	0.57	0.42	0.24	0.62	n/a	n/a
	7 (178)	0.76	0.69	0.62	0.66	0.48	0.28	0.61	0.59	0.57	0.55	0.41	0.25	0.66	0.48	0.28	0.67	n/a	n/a
	7-1/4 (184)	0.77	0.70	0.62	0.68	0.50	0.29	0.62	0.60	0.57	0.58	0.43	0.26	0.68	0.50	0.29	0.68	0.62	n/a
	8 (203)	0.80	0.72	0.63	0.75	0.55	0.32	0.63	0.61	0.57	0.67	0.50	0.30	0.75	0.55	0.32	0.71	0.65	n/a
	9 (229)	0.83	0.75	0.65	0.85	0.62	0.36	0.64	0.62	0.58	0.80	0.60	0.36	0.85	0.62	0.36	0.76	0.69	n/a
	10 (254)	0.87	0.78	0.67	0.94	0.69	0.40	0.66	0.63	0.59	0.94	0.70	0.42	0.94	0.69	0.40	0.80	0.73	n/a
	11-1/4 (286)	0.92	0.81	0.69	1.00	0.78	0.46	0.68	0.65	0.61	1.00	0.84	0.50	1.00	0.78	0.46	0.85	0.77	0.65
	12 (305)	0.94	0.83	0.70		0.83	0.49	0.69	0.66	0.61		0.92	0.55		0.83	0.49	0.87	0.79	0.67
	14 (356)	1.00	0.89	0.73		0.97	0.57	0.72	0.68	0.63		1.00	0.70		0.97	0.57	0.94	0.86	0.72
	16 (406)		0.94	0.77		1.00	0.65	0.76	0.71	0.65			0.85		1.00	0.65	1.00	0.92	0.77
	18 (457)		1.00	0.80			0.73	0.79	0.74	0.67			1.00			0.73		0.97	0.82
	20 (508)			0.83			0.81	0.82	0.76	0.69						0.81		1.00	0.87
	22 (559)			0.87			0.89	0.85	0.79	0.71						0.89			0.91
	24 (610)			0.90			0.97	0.88	0.82	0.72						0.97			0.95
30 (762)			1.00			1.00	0.98	0.89	0.78						1.00			1.00	
36 (914)							1.00	0.97	0.84										
>48 (1219)								1.00	0.95										

Table 8 — Load adjustment factors for #4 rebar in cracked concrete^{1,2,3}

	#4 Cracked Concrete	Spacing Factor in Tension f_{AN}			Edge Distance Factor in Tension f_{RN}			Spacing Factor in Shear ⁴ f_{AV}			Edge Distance in Shear						Concrete Thickness Factor in Shear ⁵ f_{HV}		
											⊥ Toward Edge f_{RV}			∥ To Edge f_{RV}					
		Embedment h_{ef} in (mm)	4-1/2 (114)	6 (152)	10 (254)	4-1/2 (114)	6 (152)	10 (254)	4-1/2 (114)	6 (152)	10 (254)	4-1/2 (114)	6 (152)	10 (254)	4-1/2 (114)	6 (152)	10 (254)	4-1/2 (114)	6 (152)
Spacing (s) / Edge Distance (c_e) / Concrete Thickness (h) — in (mm)	1-3/4 (44)	n/a	n/a	n/a	0.49	0.45	0.41	n/a	n/a	n/a	0.13	0.10	0.06	0.26	0.19	0.12	n/a	n/a	n/a
	2-1/2 (64)	0.59	0.57	0.54	0.56	0.50	0.44	0.56	0.55	0.54	0.22	0.17	0.10	0.44	0.33	0.20	n/a	n/a	n/a
	3 (76)	0.61	0.58	0.55	0.60	0.53	0.46	0.57	0.56	0.54	0.29	0.22	0.13	0.58	0.43	0.26	n/a	n/a	n/a
	4 (102)	0.65	0.61	0.57	0.70	0.60	0.49	0.60	0.58	0.56	0.45	0.33	0.20	0.70	0.60	0.40	n/a	n/a	n/a
	5 (127)	0.69	0.64	0.58	0.80	0.67	0.53	0.62	0.60	0.57	0.62	0.47	0.28	0.80	0.67	0.53	n/a	n/a	n/a
	5-3/4 (146)	0.71	0.66	0.60	0.88	0.73	0.56	0.64	0.62	0.58	0.77	0.58	0.35	0.88	0.73	0.56	0.75	n/a	n/a
	6 (152)	0.72	0.67	0.60	0.91	0.75	0.57	0.65	0.62	0.59	0.82	0.61	0.37	0.91	0.75	0.57	0.76	n/a	n/a
	7 (178)	0.76	0.69	0.62	1.00	0.83	0.62	0.67	0.64	0.60	1.00	0.77	0.46	1.00	0.83	0.62	0.83	n/a	n/a
	7-1/4 (184)	0.77	0.70	0.62		0.85	0.63	0.68	0.65	0.60		0.82	0.49		0.85	0.63	0.84	0.76	n/a
	8 (203)	0.80	0.72	0.63		0.91	0.66	0.69	0.66	0.61		0.95	0.57		0.91	0.66	0.88	0.80	n/a
	9 (229)	0.83	0.75	0.65		1.00	0.70	0.72	0.68	0.63		1.00	0.68		1.00	0.70	0.94	0.85	n/a
	10 (254)	0.87	0.78	0.67			0.75	0.74	0.70	0.64			0.79			0.75	0.99	0.90	n/a
	11-1/4 (286)	0.92	0.81	0.69			0.81	0.77	0.73	0.66			0.95			0.81	1.00	0.95	0.80
	12 (305)	0.94	0.83	0.70			0.85	0.79	0.74	0.67			1.00			0.85		0.98	0.83
	14 (356)	1.00	0.89	0.73			0.95	0.84	0.78	0.70						0.95		1.00	0.89
	16 (406)		0.94	0.77			1.00	0.89	0.82	0.73						1.00			0.96
	18 (457)		1.00	0.80				0.94	0.86	0.76									1.00
	20 (508)			0.83				0.99	0.90	0.79									
	22 (559)			0.87				1.00	0.94	0.81									
	24 (610)			0.90					0.98	0.84									
30 (762)			1.00					1.00	0.93										
36 (914)									1.00										
>48 (1219)																			

Footnotes for Tables 7 and 8

- Linear interpolation not permitted
- Shaded area with reduced edge distance is permitted provided rebar has no installation torque.
- When combining multiple load adjustment factors (e.g. for a four-anchor pattern in a corner with thin concrete member) the design can become very conservative. To optimize the design, use Hilti PROFIS Anchor Design software or perform anchor calculation using design equations from ACI 318-14 Chapter 17.
- Spacing factor reduction in shear, f_{AV} , assumes an influence of a nearby edge. If no edge exists, then $f_{AV} = f_{AN}$.
- Concrete thickness reduction factor in shear, f_{HV} , assumes an influence of a nearby edge. If no edge exists, then $f_{HV} = 1.0$.

Table 9 — Load adjustment factors for #5 rebar in uncracked concrete ^{1,2,3}

Spacing (s) / Edge Distance (c _e) / Concrete Thickness (h), — in (mm)	#5 Uncracked Concrete		Spacing Factor in Tension f _{AN}			Edge Distance Factor in Tension f _{RN}			Spacing Factor in Shear ⁴ f _{AV}			Edge Distance in Shear						Concrete Thickness Factor in Shear ⁵ f _{HV}		
												⊥ Toward Edge f _{RV}			∥ To Edge f _{RV}					
			Embedment h _{ef} in (mm)	5-5/8 (143)	7-1/2 (191)	12-1/2 (318)	5-5/8 (143)	7-1/2 (191)	12-1/2 (318)	5-5/8 (143)	7-1/2 (191)	12-1/2 (318)	5-5/8 (143)	7-1/2 (191)	12-1/2 (318)	5-5/8 (143)	7-1/2 (191)	12-1/2 (318)	5-5/8 (143)	7-1/2 (191)
1-3/4 (44)	n/a	n/a	n/a	0.25	0.19	0.11	n/a	n/a	n/a	0.05	0.04	0.02	0.10	0.08	0.05	n/a	n/a	n/a		
3-1/8 (79)	0.59	0.57	0.54	0.32	0.23	0.14	0.54	0.53	0.52	0.12	0.09	0.05	0.24	0.18	0.11	n/a	n/a	n/a		
4 (102)	0.62	0.59	0.55	0.36	0.27	0.16	0.55	0.54	0.53	0.18	0.13	0.08	0.35	0.26	0.16	n/a	n/a	n/a		
5 (127)	0.65	0.61	0.57	0.42	0.31	0.18	0.57	0.55	0.54	0.25	0.19	0.11	0.42	0.31	0.18	n/a	n/a	n/a		
6 (152)	0.68	0.63	0.58	0.47	0.35	0.20	0.58	0.56	0.55	0.32	0.24	0.15	0.47	0.35	0.20	n/a	n/a	n/a		
7 (178)	0.71	0.66	0.59	0.53	0.39	0.23	0.59	0.58	0.55	0.41	0.31	0.18	0.53	0.39	0.23	n/a	n/a	n/a		
7-1/8 (181)	0.71	0.66	0.60	0.54	0.40	0.23	0.59	0.58	0.55	0.42	0.31	0.19	0.54	0.40	0.23	0.61	n/a	n/a		
8 (203)	0.74	0.68	0.61	0.61	0.45	0.26	0.60	0.59	0.56	0.50	0.37	0.22	0.61	0.45	0.26	0.65	n/a	n/a		
9 (229)	0.77	0.70	0.62	0.69	0.51	0.30	0.62	0.60	0.57	0.60	0.45	0.27	0.69	0.51	0.30	0.69	0.62	n/a		
10 (254)	0.80	0.72	0.63	0.76	0.56	0.33	0.63	0.61	0.58	0.70	0.52	0.31	0.76	0.56	0.33	0.72	0.66	n/a		
11 (279)	0.83	0.74	0.65	0.84	0.62	0.36	0.64	0.62	0.58	0.81	0.60	0.36	0.84	0.62	0.36	0.76	0.69	n/a		
12 (305)	0.86	0.77	0.66	0.92	0.67	0.39	0.66	0.63	0.59	0.92	0.69	0.41	0.92	0.67	0.39	0.79	0.72	n/a		
14 (356)	0.91	0.81	0.69	1.00	0.79	0.46	0.68	0.65	0.61	1.00	0.87	0.52	1.00	0.79	0.46	0.86	0.78	0.66		
16 (406)	0.97	0.86	0.71		0.90	0.53	0.71	0.67	0.62		1.00	0.64		0.90	0.53	0.92	0.83	0.70		
18 (457)	1.00	0.90	0.74		1.00	0.59	0.74	0.69	0.64			0.76		1.00	0.59	0.97	0.88	0.74		
20 (508)		0.94	0.77			0.66	0.76	0.72	0.65			0.89			0.66	1.00	0.93	0.78		
22 (559)		0.99	0.79			0.72	0.79	0.74	0.67			1.00			0.72		0.98	0.82		
24 (610)		1.00	0.82			0.79	0.81	0.76	0.68						0.79		1.00	0.86		
26 (660)			0.85			0.85	0.84	0.78	0.70						0.85			0.90		
28 (711)			0.87			0.92	0.87	0.80	0.72						0.92			0.93		
30 (762)			0.90			0.99	0.89	0.82	0.73						0.99			0.96		
36 (914)			0.98			1.00	0.97	0.89	0.78						1.00			1.00		
>48 (1219)			1.00				1.00	1.00	0.87											

Table 10 — Load adjustment factors for #5 rebar in cracked concrete ^{1,2,3}

Spacing (s) / Edge Distance (c _e) / Concrete Thickness (h), — in (mm)	#5 Cracked Concrete		Spacing Factor in Tension f _{AN}			Edge Distance Factor in Tension f _{RN}			Spacing Factor in Shear ⁴ f _{AV}			Edge Distance in Shear						Concrete Thickness Factor in Shear ⁵ f _{HV}		
												⊥ Toward Edge f _{RV}			∥ To Edge f _{RV}					
			Embedment h _{ef} in (mm)	5-5/8 (143)	7-1/2 (191)	12-1/2 (318)	5-5/8 (143)	7-1/2 (191)	12-1/2 (318)	5-5/8 (143)	7-1/2 (191)	12-1/2 (318)	5-5/8 (143)	7-1/2 (191)	12-1/2 (318)	5-5/8 (143)	7-1/2 (191)	12-1/2 (318)	5-5/8 (143)	7-1/2 (191)
1-3/4 (44)	n/a	n/a	n/a	0.46	0.43	0.40	n/a	n/a	n/a	0.09	0.07	0.04	0.18	0.14	0.08	n/a	n/a	n/a		
3-1/8 (79)	0.59	0.57	0.54	0.56	0.50	0.44	0.56	0.55	0.54	0.22	0.17	0.10	0.44	0.33	0.20	n/a	n/a	n/a		
4 (102)	0.62	0.59	0.55	0.62	0.55	0.46	0.58	0.56	0.55	0.32	0.24	0.14	0.62	0.48	0.29	n/a	n/a	n/a		
5 (127)	0.65	0.61	0.57	0.70	0.60	0.49	0.60	0.58	0.56	0.45	0.33	0.20	0.70	0.60	0.40	n/a	n/a	n/a		
6 (152)	0.68	0.63	0.58	0.78	0.66	0.53	0.62	0.60	0.57	0.59	0.44	0.26	0.78	0.66	0.53	n/a	n/a	n/a		
7 (178)	0.71	0.66	0.59	0.87	0.72	0.56	0.64	0.61	0.58	0.74	0.55	0.33	0.87	0.72	0.56	n/a	n/a	n/a		
7-1/8 (181)	0.71	0.66	0.60	0.88	0.73	0.56	0.64	0.61	0.58	0.76	0.57	0.34	0.88	0.73	0.56	0.74	n/a	n/a		
8 (203)	0.74	0.68	0.61	0.96	0.78	0.59	0.66	0.63	0.59	0.90	0.68	0.41	0.96	0.78	0.59	0.79	n/a	n/a		
9 (229)	0.77	0.70	0.62	1.00	0.85	0.62	0.68	0.64	0.60	1.00	0.81	0.48	1.00	0.85	0.62	0.84	0.76	n/a		
10 (254)	0.80	0.72	0.63		0.91	0.66	0.69	0.66	0.61		0.95	0.57		0.91	0.66	0.88	0.80	n/a		
11 (279)	0.83	0.74	0.65		0.98	0.69	0.71	0.68	0.63		1.00	0.65		0.98	0.69	0.93	0.84	n/a		
12 (305)	0.86	0.77	0.66		1.00	0.73	0.73	0.69	0.64			0.75		1.00	0.73	0.97	0.88	n/a		
14 (356)	0.91	0.81	0.69			0.81	0.77	0.72	0.66			0.94			0.81	1.00	0.95	0.80		
16 (406)	0.97	0.86	0.71			0.89	0.81	0.76	0.68			1.00			0.89		1.00	0.86		
18 (457)	1.00	0.90	0.74			0.97	0.85	0.79	0.71						0.97			0.91		
20 (508)		0.94	0.77			1.00	0.89	0.82	0.73						1.00			0.96		
22 (559)		0.99	0.79				0.93	0.85	0.75									1.00		
24 (610)		1.00	0.82				0.97	0.89	0.77											
26 (660)			0.85				1.00	0.92	0.80											
28 (711)			0.87					0.95	0.82											
30 (762)			0.90					0.98	0.84											
36 (914)			0.98					1.00	0.91											
>48 (1219)			1.00						1.00											

Footnotes for Tables 9 and 10

- Linear interpolation not permitted
- Shaded area with reduced edge distance is permitted provided rebar has no installation torque.
- When combining multiple load adjustment factors (e.g. for a four-anchor pattern in a corner with thin concrete member) the design can become very conservative. To optimize the design, use Hilti PROFIS Anchor Design software or perform anchor calculation using design equations from ACI 318-14 Chapter 17.
- Spacing factor reduction in shear, f_{AV}, assumes an influence of a nearby edge. If no edge exists, then f_{AV} = f_{AN}.
- Concrete thickness reduction factor in shear, f_{HV}, assumes an influence of a nearby edge. If no edge exists, then f_{HV} = 1.0.

Table 11 — Load adjustment factors for #6 rebar in uncracked concrete ^{1,2,3}

	#6 Uncracked Concrete	Spacing Factor in Tension f_{AN}			Edge Distance Factor in Tension f_{RN}			Spacing Factor in Shear ⁴ f_{AV}			Edge Distance in Shear						Concrete Thickness Factor in Shear ⁵ f_{HV}		
											⊥ Toward Edge f_{RV}			∥ To Edge f_{RV}					
		Embedment h_{ef} in (mm)	6-3/4 (171)	9 (229)	15 (381)	6-3/4 (171)	9 (229)	15 (381)	6-3/4 (171)	9 (229)	15 (381)	6-3/4 (171)	9 (229)	15 (381)	6-3/4 (171)	9 (229)	15 (381)	6-3/4 (171)	9 (229)
Spacing (s) / Edge Distance (c_e) / Concrete Thickness (h), — in (mm)	1-3/4 (44)	n/a	n/a	n/a	0.24	0.18	0.10	n/a	n/a	n/a	0.04	0.03	0.02	0.08	0.06	0.04	n/a	n/a	n/a
	3-3/4 (95)	0.59	0.57	0.54	0.32	0.23	0.14	0.54	0.53	0.52	0.12	0.09	0.06	0.25	0.19	0.11	n/a	n/a	n/a
	4 (102)	0.60	0.57	0.54	0.33	0.24	0.14	0.54	0.54	0.53	0.14	0.10	0.06	0.27	0.20	0.12	n/a	n/a	n/a
	5 (127)	0.62	0.59	0.56	0.37	0.27	0.16	0.56	0.55	0.53	0.19	0.14	0.09	0.37	0.27	0.16	n/a	n/a	n/a
	6 (152)	0.65	0.61	0.57	0.42	0.31	0.18	0.57	0.55	0.54	0.25	0.19	0.11	0.42	0.31	0.18	n/a	n/a	n/a
	7 (178)	0.67	0.63	0.58	0.47	0.34	0.20	0.58	0.56	0.55	0.32	0.24	0.14	0.47	0.34	0.20	n/a	n/a	n/a
	8 (203)	0.70	0.65	0.59	0.52	0.38	0.22	0.59	0.57	0.55	0.39	0.29	0.17	0.52	0.38	0.22	n/a	n/a	n/a
	8-1/2 (216)	0.71	0.66	0.59	0.55	0.40	0.24	0.59	0.58	0.56	0.42	0.32	0.19	0.55	0.40	0.24	0.61	n/a	n/a
	9 (229)	0.72	0.67	0.60	0.58	0.43	0.25	0.60	0.58	0.56	0.46	0.34	0.21	0.58	0.43	0.25	0.63	n/a	n/a
	10 (254)	0.75	0.69	0.61	0.64	0.47	0.28	0.61	0.59	0.56	0.54	0.40	0.24	0.64	0.47	0.28	0.66	n/a	n/a
	10-3/4 (273)	0.77	0.70	0.62	0.69	0.51	0.30	0.62	0.60	0.57	0.60	0.45	0.27	0.69	0.51	0.30	0.69	0.63	n/a
	12 (305)	0.80	0.72	0.63	0.77	0.57	0.33	0.63	0.61	0.58	0.71	0.53	0.32	0.77	0.57	0.33	0.73	0.66	n/a
	14 (356)	0.85	0.76	0.66	0.90	0.66	0.39	0.65	0.63	0.59	0.89	0.67	0.40	0.90	0.66	0.39	0.79	0.71	n/a
	16 (406)	0.90	0.80	0.68	1.00	0.76	0.44	0.68	0.65	0.60	1.00	0.82	0.49	1.00	0.76	0.44	0.84	0.76	n/a
	16-3/4 (425)	0.91	0.81	0.69		0.79	0.46	0.68	0.65	0.61		0.87	0.52		0.79	0.46	0.86	0.78	0.66
	18 (457)	0.94	0.83	0.70		0.85	0.50	0.70	0.66	0.62		0.97	0.58		0.85	0.50	0.89	0.81	0.68
	20 (508)	0.99	0.87	0.72		0.95	0.55	0.72	0.68	0.63		1.00	0.68		0.95	0.55	0.94	0.85	0.72
	22 (559)	1.00	0.91	0.74		1.00	0.61	0.74	0.70	0.64			0.79		1.00	0.61	0.99	0.89	0.75
	24 (610)		0.94	0.77			0.67	0.76	0.72	0.66			0.90			0.67	1.00	0.93	0.79
	26 (660)		0.98	0.79			0.72	0.79	0.74	0.67			1.00			0.72		0.97	0.82
28 (711)		1.00	0.81			0.78	0.81	0.75	0.68						0.78		1.00	0.85	
30 (762)			0.83			0.83	0.83	0.77	0.69						0.83			0.88	
36 (914)			0.90			1.00	0.90	0.83	0.73						1.00			0.97	
>48 (1219)			1.00				1.00	0.94	0.81									1.00	

Table 12 — Load adjustment factors for #6 rebar in cracked concrete ^{1,2,3}

	#6 Cracked Concrete	Spacing Factor in Tension f_{AN}			Edge Distance Factor in Tension f_{RN}			Spacing Factor in Shear ⁴ f_{AV}			Edge Distance in Shear						Concrete Thickness Factor in Shear ⁵ f_{HV}		
											⊥ Toward Edge f_{RV}			∥ To Edge f_{RV}					
		Embedment h_{ef} in (mm)	6-3/4 (171)	9 (229)	15 (381)	6-3/4 (171)	9 (229)	15 (381)	6-3/4 (171)	9 (229)	15 (381)	6-3/4 (171)	9 (229)	15 (381)	6-3/4 (171)	9 (229)	15 (381)	6-3/4 (171)	9 (229)
Spacing (s) / Edge Distance (c_e) / Concrete Thickness (h), — in (mm)	1-3/4 (44)	n/a	n/a	n/a	0.44	0.42	0.39	n/a	n/a	n/a	0.07	0.05	0.03	0.14	0.10	0.06	n/a	n/a	n/a
	3-3/4 (95)	0.59	0.57	0.54	0.56	0.50	0.44	0.56	0.55	0.54	0.22	0.16	0.10	0.43	0.32	0.19	n/a	n/a	n/a
	4 (102)	0.60	0.57	0.54	0.57	0.51	0.44	0.56	0.55	0.54	0.24	0.18	0.11	0.48	0.36	0.21	n/a	n/a	n/a
	5 (127)	0.62	0.59	0.56	0.63	0.56	0.47	0.58	0.57	0.55	0.33	0.25	0.15	0.63	0.50	0.30	n/a	n/a	n/a
	6 (152)	0.65	0.61	0.57	0.70	0.60	0.49	0.60	0.58	0.56	0.44	0.33	0.20	0.70	0.60	0.39	n/a	n/a	n/a
	7 (178)	0.67	0.63	0.58	0.77	0.65	0.52	0.61	0.59	0.57	0.55	0.41	0.25	0.77	0.65	0.50	n/a	n/a	n/a
	8 (203)	0.70	0.65	0.59	0.84	0.70	0.55	0.63	0.61	0.58	0.67	0.50	0.30	0.84	0.70	0.55	n/a	n/a	n/a
	8-1/2 (216)	0.71	0.66	0.59	0.88	0.72	0.56	0.64	0.61	0.58	0.74	0.55	0.33	0.88	0.72	0.56	0.74	n/a	n/a
	9 (229)	0.72	0.67	0.60	0.91	0.75	0.57	0.64	0.62	0.58	0.80	0.60	0.36	0.91	0.75	0.57	0.76	n/a	n/a
	10 (254)	0.75	0.69	0.61	0.99	0.80	0.60	0.66	0.63	0.59	0.94	0.70	0.42	0.99	0.80	0.60	0.80	n/a	n/a
	10-3/4 (273)	0.77	0.70	0.62	1.00	0.84	0.62	0.67	0.64	0.60	1.00	0.79	0.47	1.00	0.84	0.62	0.83	0.75	n/a
	12 (305)	0.80	0.72	0.63		0.91	0.66	0.69	0.66	0.61		0.93	0.56		0.91	0.66	0.88	0.80	n/a
	14 (356)	0.85	0.76	0.66		1.00	0.72	0.72	0.68	0.63		1.00	0.70		1.00	0.72	0.95	0.86	n/a
	16 (406)	0.90	0.80	0.68			0.78	0.76	0.71	0.65			0.86			0.78	1.00	0.92	n/a
	16-3/4 (425)	0.91	0.81	0.69			0.81	0.77	0.72	0.66			0.92			0.81		0.94	0.79
	18 (457)	0.94	0.83	0.70			0.85	0.79	0.74	0.67			1.00			0.85		0.97	0.82
	20 (508)	0.99	0.87	0.72			0.91	0.82	0.76	0.69						0.91		1.00	0.87
	22 (559)	1.00	0.91	0.74			0.98	0.85	0.79	0.71						0.98			0.91
	24 (610)		0.94	0.77			1.00	0.88	0.82	0.73						1.00			0.95
	26 (660)		0.98	0.79				0.92	0.84	0.74									0.99
28 (711)		1.00	0.81				0.95	0.87	0.76									1.00	
30 (762)			0.83				0.98	0.90	0.78										
36 (914)			0.90				1.00	0.98	0.84										
>48 (1219)			1.00					1.00	0.95										

Footnotes for Tables 11 and 12

- 1 Linear interpolation not permitted
- 2 Shaded area with reduced edge distance is permitted provided rebar has no installation torque.
- 3 When combining multiple load adjustment factors (e.g. for a four-anchor pattern in a corner with thin concrete member) the design can become very conservative. To optimize the design, use Hilti PROFIS Anchor Design software or perform anchor calculation using design equations from ACI 318-14 Chapter 17.
- 4 Spacing factor reduction in shear, f_{AV} , assumes an influence of a nearby edge. If no edge exists, then $f_{AV} = f_{AN}$.
- 5 Concrete thickness reduction factor in shear, f_{HV} , assumes an influence of a nearby edge. If no edge exists, then $f_{HV} = 1.0$.

Table 13 — Load adjustment factors for #7 rebar in uncracked concrete ^{1,2,3}

#7 Uncracked Concrete	Spacing Factor in Tension			Edge Distance Factor in Tension			Spacing Factor in Shear ⁴			Edge Distance in Shear						Concrete Thickness Factor in Shear ⁵			
	f_{AN}			f_{RN}			f_{AV}			⊥ Toward Edge f_{RV}			∥ To Edge f_{RV}			f_{HV}			
	Embedment h_{ef} in (mm)	7-7/8 (200)	10-1/2 (267)	17-1/2 (445)	7-7/8 (200)	10-1/2 (267)	17-1/2 (445)	7-7/8 (200)	10-1/2 (267)	17-1/2 (445)	7-7/8 (200)	10-1/2 (267)	17-1/2 (445)	7-7/8 (200)	10-1/2 (267)	17-1/2 (445)	7-7/8 (200)	10-1/2 (267)	17-1/2 (445)
Spacing (s) / Edge Distance (c_e) / Concrete Thickness (h), — in (mm)	1-3/4 (44)	n/a	n/a	n/a	0.23	0.17	0.10	n/a	n/a	n/a	0.03	0.02	0.01	0.06	0.04	0.03	n/a	n/a	n/a
	4-3/8 (111)	0.59	0.57	0.54	0.32	0.24	0.14	0.54	0.53	0.52	0.12	0.09	0.05	0.24	0.18	0.11	n/a	n/a	n/a
	5 (127)	0.61	0.58	0.55	0.34	0.25	0.15	0.55	0.54	0.53	0.14	0.11	0.07	0.29	0.22	0.13	n/a	n/a	n/a
	6 (152)	0.63	0.60	0.56	0.38	0.28	0.16	0.56	0.55	0.53	0.19	0.14	0.09	0.38	0.28	0.16	n/a	n/a	n/a
	7 (178)	0.65	0.61	0.57	0.42	0.31	0.18	0.56	0.55	0.54	0.24	0.18	0.11	0.42	0.31	0.18	n/a	n/a	n/a
	8 (203)	0.67	0.63	0.58	0.46	0.34	0.20	0.57	0.56	0.54	0.29	0.22	0.13	0.46	0.34	0.20	n/a	n/a	n/a
	9 (229)	0.69	0.64	0.59	0.51	0.37	0.22	0.58	0.57	0.55	0.35	0.26	0.16	0.51	0.37	0.22	n/a	n/a	n/a
	9-7/8 (251)	0.71	0.66	0.59	0.55	0.41	0.24	0.59	0.57	0.55	0.40	0.30	0.18	0.55	0.41	0.24	0.60	n/a	n/a
	10 (254)	0.71	0.66	0.60	0.56	0.41	0.24	0.59	0.58	0.55	0.41	0.31	0.18	0.56	0.41	0.24	0.61	n/a	n/a
	11 (279)	0.73	0.67	0.60	0.61	0.45	0.26	0.60	0.58	0.56	0.47	0.35	0.21	0.61	0.45	0.26	0.64	n/a	n/a
	12 (305)	0.75	0.69	0.61	0.67	0.49	0.29	0.61	0.59	0.56	0.54	0.40	0.24	0.67	0.49	0.29	0.66	n/a	n/a
	12-1/2 (318)	0.76	0.70	0.62	0.70	0.51	0.30	0.61	0.59	0.57	0.57	0.43	0.26	0.70	0.51	0.30	0.68	0.62	n/a
	14 (356)	0.80	0.72	0.63	0.78	0.58	0.34	0.63	0.61	0.58	0.68	0.51	0.31	0.78	0.58	0.34	0.72	0.65	n/a
	16 (406)	0.84	0.75	0.65	0.89	0.66	0.39	0.65	0.62	0.59	0.83	0.62	0.37	0.89	0.66	0.39	0.77	0.70	n/a
	18 (457)	0.88	0.79	0.67	1.00	0.74	0.43	0.67	0.64	0.60	0.99	0.74	0.44	1.00	0.74	0.43	0.81	0.74	n/a
	19-1/2 (495)	0.91	0.81	0.69		0.80	0.47	0.68	0.65	0.61	1.00	0.84	0.50		0.80	0.47	0.85	0.77	0.65
	20 (508)	0.92	0.82	0.69		0.82	0.48	0.68	0.65	0.61		0.87	0.52		0.82	0.48	0.86	0.78	0.66
	22 (559)	0.97	0.85	0.71		0.90	0.53	0.70	0.67	0.62		1.00	0.60		0.90	0.53	0.90	0.82	0.69
	24 (610)	1.00	0.88	0.73		0.99	0.58	0.72	0.68	0.63			0.68		0.99	0.58	0.94	0.85	0.72
	26 (660)		0.91	0.75		1.00	0.63	0.74	0.70	0.64			0.77		1.00	0.63	0.98	0.89	0.75
28 (711)		0.94	0.77			0.67	0.76	0.71	0.65			0.86			0.67	1.00	0.92	0.78	
30 (762)		0.98	0.79			0.72	0.78	0.73	0.66			0.96			0.72		0.95	0.80	
36 (914)		1.00	0.84			0.87	0.83	0.77	0.69			1.00			0.87		1.00	0.88	
>48 (1219)			0.96			1.00	0.94	0.86	0.76						1.00			1.00	

Table 14 — Load adjustment factors for #7 rebar in cracked concrete ^{1,2,3}

#7 Cracked Concrete	Spacing Factor in Tension			Edge Distance Factor in Tension			Spacing Factor in Shear ⁴			Edge Distance in Shear						Concrete Thickness Factor in Shear ⁵			
	f_{AN}			f_{RN}			f_{AV}			⊥ Toward Edge f_{RV}			∥ To Edge f_{RV}			f_{HV}			
	Embedment h_{ef} in (mm)	7-7/8 (200)	10-1/2 (267)	17-1/2 (445)	7-7/8 (200)	10-1/2 (267)	17-1/2 (445)	7-7/8 (200)	10-1/2 (267)	17-1/2 (445)	7-7/8 (200)	10-1/2 (267)	17-1/2 (445)	7-7/8 (200)	10-1/2 (267)	17-1/2 (445)	7-7/8 (200)	10-1/2 (267)	17-1/2 (445)
Spacing (s) / Edge Distance (c_e) / Concrete Thickness (h), — in (mm)	1-3/4 (44)	n/a	n/a	n/a	0.43	0.41	0.38	n/a	n/a	n/a	0.05	0.04	0.02	0.10	0.08	0.05	n/a	n/a	n/a
	4-3/8 (111)	0.59	0.57	0.54	0.56	0.50	0.44	0.56	0.55	0.53	0.20	0.15	0.09	0.40	0.30	0.18	n/a	n/a	n/a
	5 (127)	0.61	0.58	0.55	0.59	0.52	0.45	0.57	0.55	0.54	0.24	0.18	0.11	0.49	0.37	0.22	n/a	n/a	n/a
	6 (152)	0.63	0.60	0.56	0.64	0.56	0.47	0.58	0.56	0.55	0.32	0.24	0.14	0.64	0.48	0.29	n/a	n/a	n/a
	7 (178)	0.65	0.61	0.57	0.70	0.60	0.49	0.59	0.58	0.55	0.40	0.30	0.18	0.70	0.60	0.36	n/a	n/a	n/a
	8 (203)	0.67	0.63	0.58	0.76	0.64	0.52	0.60	0.59	0.56	0.49	0.37	0.22	0.76	0.64	0.44	n/a	n/a	n/a
	9 (229)	0.69	0.64	0.59	0.82	0.68	0.54	0.62	0.60	0.57	0.59	0.44	0.27	0.82	0.68	0.53	n/a	n/a	n/a
	9-7/8 (251)	0.71	0.66	0.59	0.87	0.72	0.56	0.63	0.61	0.58	0.68	0.51	0.30	0.87	0.72	0.56	0.72	n/a	n/a
	10 (254)	0.71	0.66	0.60	0.88	0.73	0.56	0.63	0.61	0.58	0.69	0.52	0.31	0.88	0.73	0.56	0.72	n/a	n/a
	11 (279)	0.73	0.67	0.60	0.95	0.77	0.59	0.64	0.62	0.58	0.80	0.60	0.36	0.95	0.77	0.59	0.76	n/a	n/a
	12 (305)	0.75	0.69	0.61	1.00	0.82	0.61	0.66	0.63	0.59	0.91	0.68	0.41	1.00	0.82	0.61	0.79	n/a	n/a
	12-1/2 (318)	0.76	0.70	0.62		0.84	0.62	0.66	0.63	0.60	0.97	0.72	0.43		0.84	0.62	0.81	0.73	n/a
	14 (356)	0.80	0.72	0.63		0.91	0.66	0.68	0.65	0.61	1.00	0.86	0.51		0.91	0.66	0.85	0.78	n/a
	16 (406)	0.84	0.75	0.65		1.00	0.71	0.71	0.67	0.62		1.00	0.63		1.00	0.71	0.91	0.83	n/a
	18 (457)	0.88	0.79	0.67			0.76	0.73	0.69	0.64			0.75			0.76	0.97	0.88	n/a
	19-1/2 (495)	0.91	0.81	0.69			0.80	0.75	0.71	0.65			0.85			0.80	1.00	0.92	0.77
	20 (508)	0.92	0.82	0.69			0.82	0.76	0.71	0.65			0.88				0.93	0.78	
	22 (559)	0.97	0.85	0.71			0.87	0.79	0.74	0.67			1.00			0.87		0.97	0.82
	24 (610)	1.00	0.88	0.73			0.93	0.81	0.76	0.68						0.93		1.00	0.86
	26 (660)		0.91	0.75			0.99	0.84	0.78	0.70						0.99			0.89
28 (711)		0.94	0.77			1.00	0.86	0.80	0.71						1.00			0.93	
30 (762)		0.98	0.79				0.89	0.82	0.73									0.96	
36 (914)		1.00	0.84				0.97	0.89	0.78									1.00	
>48 (1219)			0.96				1.00	1.00	0.87										

Footnotes for Tables 13 and 14

- 1 Linear interpolation not permitted
- 2 Shaded area with reduced edge distance is permitted provided rebar has no installation torque.
- 3 When combining multiple load adjustment factors (e.g. for a four-anchor pattern in a corner with thin concrete member) the design can become very conservative. To optimize the design, use Hilti PROFIS Anchor Design software or perform anchor calculation using design equations from ACI 318-14 Chapter 17.
- 4 Spacing factor reduction in shear, f_{AV} , assumes an influence of a nearby edge. If no edge exists, then $f_{AV} = f_{AN}$.
- 5 Concrete thickness reduction factor in shear, f_{HV} , assumes an influence of a nearby edge. If no edge exists, then $f_{HV} = 1.0$.

Table 15 — Load adjustment factors for #8 rebar in uncracked concrete ^{1,2,3}

#8 Uncracked Concrete	Spacing Factor in Tension			Edge Distance Factor in Tension			Spacing Factor in Shear ⁴			Edge Distance in Shear						Concrete Thickness Factor in Shear ⁵			
	f_{AN}			f_{RN}			f_{AV}			⊥ Toward Edge f_{RV}			∥ To Edge f_{RV}			f_{HV}			
	Embedment h_{ef} in (mm)	9 (229)	12 (305)	20 (508)	9 (229)	12 (305)	20 (508)	9 (229)	12 (305)	20 (508)	9 (229)	12 (305)	20 (508)	9 (229)	12 (305)	20 (508)	9 (229)	12 (305)	20 (508)
Spacing (s) / Edge Distance (c_a) / Concrete Thickness (h), — in (mm)	1-3/4 (44)	n/a	n/a	n/a	0.23	0.17	0.10	n/a	n/a	n/a	0.02	0.02	0.01	0.05	0.04	0.02	n/a	n/a	n/a
	5 (127)	0.59	0.57	0.54	0.32	0.24	0.14	0.54	0.53	0.52	0.11	0.09	0.05	0.23	0.17	0.10	n/a	n/a	n/a
	6 (152)	0.61	0.58	0.55	0.35	0.26	0.15	0.55	0.54	0.53	0.15	0.11	0.07	0.30	0.22	0.13	n/a	n/a	n/a
	7 (178)	0.63	0.60	0.56	0.39	0.29	0.17	0.55	0.55	0.53	0.19	0.14	0.09	0.38	0.28	0.17	n/a	n/a	n/a
	8 (203)	0.65	0.61	0.57	0.42	0.31	0.18	0.56	0.55	0.54	0.23	0.17	0.10	0.42	0.31	0.18	n/a	n/a	n/a
	9 (229)	0.67	0.63	0.58	0.46	0.34	0.20	0.57	0.56	0.54	0.28	0.21	0.12	0.46	0.34	0.20	n/a	n/a	n/a
	10 (254)	0.69	0.64	0.58	0.50	0.37	0.21	0.58	0.56	0.55	0.32	0.24	0.15	0.50	0.37	0.21	n/a	n/a	n/a
	11 (279)	0.70	0.65	0.59	0.54	0.40	0.23	0.59	0.57	0.55	0.37	0.28	0.17	0.54	0.40	0.23	n/a	n/a	n/a
	11-1/4 (286)	0.71	0.66	0.59	0.56	0.41	0.24	0.59	0.57	0.55	0.38	0.29	0.17	0.56	0.41	0.24	0.59	n/a	n/a
	12 (305)	0.72	0.67	0.60	0.59	0.44	0.26	0.59	0.58	0.56	0.42	0.32	0.19	0.59	0.44	0.26	0.61	n/a	n/a
	13 (330)	0.74	0.68	0.61	0.64	0.47	0.28	0.60	0.58	0.56	0.48	0.36	0.22	0.64	0.47	0.28	0.64	n/a	n/a
	14 (356)	0.76	0.69	0.62	0.69	0.51	0.30	0.61	0.59	0.56	0.53	0.40	0.24	0.69	0.51	0.30	0.66	n/a	n/a
	14-1/4 (362)	0.76	0.70	0.62	0.70	0.52	0.30	0.61	0.59	0.57	0.55	0.41	0.25	0.70	0.52	0.30	0.67	0.61	n/a
	16 (406)	0.80	0.72	0.63	0.79	0.58	0.34	0.63	0.60	0.57	0.65	0.49	0.29	0.79	0.58	0.34	0.71	0.64	n/a
	18 (457)	0.83	0.75	0.65	0.89	0.65	0.38	0.64	0.62	0.58	0.78	0.58	0.35	0.89	0.65	0.38	0.75	0.68	n/a
	20 (508)	0.87	0.78	0.67	0.99	0.73	0.43	0.66	0.63	0.59	0.91	0.68	0.41	0.99	0.73	0.43	0.79	0.72	n/a
	22 (559)	0.91	0.81	0.68	1.00	0.80	0.47	0.67	0.64	0.60	1.00	0.79	0.47	1.00	0.80	0.47	0.83	0.75	n/a
	22-1/4 (565)	0.91	0.81	0.69		0.81	0.47	0.67	0.64	0.60		0.80	0.48		0.81	0.47	0.84	0.76	0.64
	24 (610)	0.94	0.83	0.70		0.87	0.51	0.69	0.66	0.61		0.90	0.54		0.87	0.51	0.87	0.79	0.66
	26 (660)	0.98	0.86	0.72		0.94	0.55	0.70	0.67	0.62		1.00	0.61		0.94	0.55	0.90	0.82	0.69
28 (711)	1.00	0.89	0.73		1.00	0.60	0.72	0.68	0.63			0.68		1.00	0.60	0.94	0.85	0.72	
30 (762)		0.92	0.75			0.64	0.74	0.69	0.64			0.75			0.64	0.97	0.88	0.74	
36 (914)		1.00	0.80			0.77	0.78	0.73	0.67			0.99			0.77	1.00	0.97	0.81	
>48 (1219)			0.90			1.00	0.88	0.81	0.72			1.00			1.00	1.00	0.94	0.94	

Table 16 — Load adjustment factors for #8 rebar in cracked concrete ^{1,2,3}

#8 Cracked Concrete	Spacing Factor in Tension			Edge Distance Factor in Tension			Spacing Factor in Shear ⁴			Edge Distance in Shear						Concrete Thickness Factor in Shear ⁵			
	f_{AN}			f_{RN}			f_{AV}			⊥ Toward Edge f_{RV}			∥ To Edge f_{RV}			f_{HV}			
	Embedment h_{ef} in (mm)	9 (229)	12 (305)	20 (508)	9 (229)	12 (305)	20 (508)	9 (229)	12 (305)	20 (508)	9 (229)	12 (305)	20 (508)	9 (229)	12 (305)	20 (508)	9 (229)	12 (305)	20 (508)
Spacing (s) / Edge Distance (c_a) / Concrete Thickness (h), — in (mm)	1-3/4 (44)	n/a	n/a	n/a	0.42	0.40	0.38	n/a	n/a	n/a	0.04	0.03	0.02	0.08	0.06	0.04	n/a	n/a	n/a
	5 (127)	0.59	0.57	0.54	0.56	0.50	0.44	0.56	0.55	0.53	0.20	0.15	0.09	0.39	0.30	0.18	n/a	n/a	n/a
	6 (152)	0.61	0.58	0.55	0.60	0.53	0.46	0.57	0.56	0.54	0.26	0.19	0.12	0.52	0.39	0.23	n/a	n/a	n/a
	7 (178)	0.63	0.60	0.56	0.65	0.57	0.47	0.58	0.57	0.55	0.33	0.24	0.15	0.65	0.49	0.29	n/a	n/a	n/a
	8 (203)	0.65	0.61	0.57	0.70	0.60	0.49	0.59	0.57	0.55	0.40	0.30	0.18	0.70	0.60	0.36	n/a	n/a	n/a
	9 (229)	0.67	0.63	0.58	0.75	0.64	0.51	0.60	0.58	0.56	0.48	0.36	0.21	0.75	0.64	0.43	n/a	n/a	n/a
	10 (254)	0.69	0.64	0.58	0.80	0.67	0.53	0.61	0.59	0.57	0.56	0.42	0.25	0.80	0.67	0.50	n/a	n/a	n/a
	11 (279)	0.70	0.65	0.59	0.86	0.71	0.55	0.62	0.60	0.57	0.64	0.48	0.29	0.86	0.71	0.55	n/a	n/a	n/a
	11-1/4 (286)	0.71	0.66	0.59	0.87	0.72	0.56	0.63	0.60	0.57	0.66	0.50	0.30	0.87	0.72	0.56	0.71	n/a	n/a
	12 (305)	0.72	0.67	0.60	0.91	0.75	0.57	0.64	0.61	0.58	0.73	0.55	0.33	0.91	0.75	0.57	0.74	n/a	n/a
	13 (330)	0.74	0.68	0.61	0.97	0.79	0.59	0.65	0.62	0.59	0.83	0.62	0.37	0.97	0.79	0.59	0.77	n/a	n/a
	14 (356)	0.76	0.69	0.62	1.00	0.83	0.62	0.66	0.63	0.59	0.92	0.69	0.42	1.00	0.83	0.62	0.79	n/a	n/a
	14-1/4 (362)	0.76	0.70	0.62		0.84	0.62	0.66	0.63	0.59	0.95	0.71	0.43		0.84	0.62	0.80	0.73	n/a
	16 (406)	0.80	0.72	0.63		0.91	0.66	0.68	0.65	0.61	1.00	0.85	0.51		0.91	0.66	0.85	0.77	n/a
	18 (457)	0.83	0.75	0.65		1.00	0.70	0.70	0.67	0.62		1.00	0.61		1.00	0.70	0.90	0.82	n/a
	20 (508)	0.87	0.78	0.67			0.75	0.73	0.69	0.63			0.71			0.75	0.95	0.86	n/a
	22 (559)	0.91	0.81	0.68			0.80	0.75	0.70	0.65			0.82			0.80	1.00	0.91	n/a
	22-1/4 (565)	0.91	0.81	0.69			0.80	0.75	0.71	0.65			0.83			0.80		0.91	0.77
	24 (610)	0.94	0.83	0.70			0.85	0.77	0.72	0.66			0.93			0.85		0.95	0.80
	26 (660)	0.98	0.86	0.72			0.90	0.79	0.74	0.67			1.00			0.90		0.98	0.83
28 (711)	1.00	0.89	0.73			0.95	0.82	0.76	0.69						0.95		1.00	0.86	
30 (762)		0.92	0.75			1.00	0.84	0.78	0.70						1.00			0.89	
36 (914)		1.00	0.80				0.91	0.84	0.74									0.98	
>48 (1219)			0.90				1.00	0.95	0.82									1.00	

Footnotes for Tables 15 and 16

- Linear interpolation not permitted
- Shaded area with reduced edge distance is permitted provided rebar has no installation torque.
- When combining multiple load adjustment factors (e.g. for a four-anchor pattern in a corner with thin concrete member) the design can become very conservative. To optimize the design, use Hilti PROFIS Anchor Design software or perform anchor calculation using design equations from ACI 318-14 Chapter 17.
- Spacing factor reduction in shear, f_{AV} , assumes an influence of a nearby edge. If no edge exists, then $f_{AV} = f_{AN}$.
- Concrete thickness reduction factor in shear, f_{HV} , assumes an influence of a nearby edge. If no edge exists, then $f_{HV} = 1.0$.

Table 17 — Load adjustment factors for #9 rebar in uncracked concrete ^{1,2,3}

Spacing (s) / Edge Distance (c _e) / Concrete Thickness (h), — in (mm)	#9 Uncracked Concrete	Spacing Factor in Tension			Edge Distance Factor in Tension			Spacing Factor in Shear ⁴			Edge Distance in Shear						Concrete Thickness Factor in Shear ⁵		
		f _{AN}			f _{RN}			f _{AV}			⊥ Toward Edge f _{RV}			∥ To Edge f _{RV}			f _{HV}		
		10-1/8 (257)	13-1/2 (343)	22-1/2 (572)	10-1/8 (257)	13-1/2 (343)	22-1/2 (572)	10-1/8 (257)	13-1/2 (343)	22-1/2 (572)	10-1/8 (257)	13-1/2 (343)	22-1/2 (572)	10-1/8 (257)	13-1/2 (343)	22-1/2 (572)	10-1/8 (257)	13-1/2 (343)	22-1/2 (572)
1-3/4 (44)	n/a	n/a	n/a	0.22	0.16	0.10	n/a	n/a	n/a	0.02	0.01	0.01	0.04	0.03	0.02	n/a	n/a	n/a	
5-5/8 (143)	0.59	0.57	0.54	0.32	0.24	0.14	0.54	0.53	0.52	0.11	0.08	0.05	0.22	0.16	0.10	n/a	n/a	n/a	
6 (152)	0.60	0.57	0.54	0.34	0.25	0.14	0.54	0.53	0.52	0.12	0.09	0.05	0.24	0.18	0.11	n/a	n/a	n/a	
7 (178)	0.62	0.59	0.55	0.37	0.27	0.16	0.55	0.54	0.53	0.15	0.11	0.07	0.31	0.23	0.14	n/a	n/a	n/a	
8 (203)	0.63	0.60	0.56	0.40	0.29	0.17	0.55	0.54	0.53	0.19	0.14	0.08	0.37	0.28	0.17	n/a	n/a	n/a	
9 (229)	0.65	0.61	0.57	0.43	0.31	0.18	0.56	0.55	0.54	0.22	0.17	0.10	0.43	0.31	0.18	n/a	n/a	n/a	
10 (254)	0.66	0.62	0.57	0.46	0.34	0.20	0.57	0.56	0.54	0.26	0.20	0.12	0.46	0.34	0.20	n/a	n/a	n/a	
11 (279)	0.68	0.64	0.58	0.50	0.36	0.21	0.57	0.56	0.54	0.30	0.23	0.14	0.50	0.36	0.21	n/a	n/a	n/a	
12 (305)	0.70	0.65	0.59	0.54	0.39	0.23	0.58	0.57	0.55	0.34	0.26	0.15	0.54	0.39	0.23	n/a	n/a	n/a	
12-7/8 (327)	0.71	0.66	0.60	0.57	0.42	0.25	0.59	0.57	0.55	0.38	0.29	0.17	0.57	0.42	0.25	0.59	n/a	n/a	
13 (330)	0.71	0.66	0.60	0.58	0.43	0.25	0.59	0.57	0.55	0.39	0.29	0.17	0.58	0.43	0.25	0.59	n/a	n/a	
14 (356)	0.73	0.67	0.60	0.62	0.46	0.27	0.60	0.58	0.56	0.43	0.32	0.19	0.62	0.46	0.27	0.62	n/a	n/a	
16 (406)	0.76	0.70	0.62	0.71	0.52	0.31	0.61	0.59	0.56	0.53	0.40	0.24	0.71	0.52	0.31	0.66	n/a	n/a	
16-1/4 (413)	0.77	0.70	0.62	0.72	0.53	0.31	0.61	0.59	0.56	0.54	0.40	0.24	0.72	0.53	0.31	0.66	0.60	n/a	
18 (457)	0.80	0.72	0.63	0.80	0.59	0.35	0.62	0.60	0.57	0.63	0.47	0.28	0.80	0.59	0.35	0.70	0.64	n/a	
20 (508)	0.83	0.75	0.65	0.89	0.66	0.38	0.64	0.61	0.58	0.74	0.55	0.33	0.89	0.66	0.38	0.74	0.67	n/a	
22 (559)	0.86	0.77	0.66	0.98	0.72	0.42	0.65	0.62	0.59	0.85	0.64	0.38	0.98	0.72	0.42	0.77	0.70	n/a	
24 (610)	0.90	0.80	0.68	1.00	0.79	0.46	0.66	0.63	0.60	0.97	0.73	0.44	1.00	0.79	0.46	0.81	0.73	n/a	
25-1/4 (641)	0.92	0.81	0.69		0.83	0.48	0.67	0.64	0.60	1.00	0.78	0.47		0.83	0.48	0.83	0.75	0.64	
26 (660)	0.93	0.82	0.69		0.85	0.50	0.68	0.65	0.60		0.82	0.49		0.85	0.50	0.84	0.76	0.64	
28 (711)	0.96	0.85	0.71		0.92	0.54	0.69	0.66	0.61		0.92	0.55		0.92	0.54	0.87	0.79	0.67	
30 (762)	0.99	0.87	0.72		0.98	0.58	0.70	0.67	0.62		1.00	0.61		0.98	0.58	0.90	0.82	0.69	
36 (914)	1.00	0.94	0.77		1.00	0.69	0.74	0.70	0.64			0.80		1.00	0.69	0.99	0.90	0.76	
>48 (1219)		1.00	0.86			0.92	0.83	0.77	0.69			1.00			0.92	1.00	1.00	0.88	

Table 18 — Load adjustment factors for #9 rebar in cracked concrete ^{1,2,3}

Spacing (s) / Edge Distance (c _e) / Concrete Thickness (h), — in (mm)	#9 Cracked Concrete	Spacing Factor in Tension			Edge Distance Factor in Tension			Spacing Factor in Shear ⁴			Edge Distance in Shear						Concrete Thickness Factor in Shear ⁵		
		f _{AN}			f _{RN}			f _{AV}			⊥ Toward Edge f _{RV}			∥ To Edge f _{RV}			f _{HV}		
		10-1/8 (257)	13-1/2 (343)	22-1/2 (572)	10-1/8 (257)	13-1/2 (343)	22-1/2 (572)	10-1/8 (257)	13-1/2 (343)	22-1/2 (572)	10-1/8 (257)	13-1/2 (343)	22-1/2 (572)	10-1/8 (257)	13-1/2 (343)	22-1/2 (572)	10-1/8 (257)	13-1/2 (343)	22-1/2 (572)
1-3/4 (44)	n/a	n/a	n/a	0.41	0.39	0.38	n/a	n/a	n/a	0.03	0.03	0.02	0.07	0.05	0.03	n/a	n/a	n/a	
5-5/8 (143)	0.59	0.57	0.54	0.56	0.50	0.44	0.56	0.55	0.53	0.20	0.15	0.09	0.39	0.29	0.18	n/a	n/a	n/a	
6 (152)	0.60	0.57	0.54	0.57	0.51	0.44	0.56	0.55	0.54	0.22	0.16	0.10	0.43	0.32	0.19	n/a	n/a	n/a	
7 (178)	0.62	0.59	0.55	0.61	0.54	0.46	0.57	0.56	0.54	0.27	0.20	0.12	0.54	0.41	0.24	n/a	n/a	n/a	
8 (203)	0.63	0.60	0.56	0.65	0.57	0.48	0.58	0.57	0.55	0.33	0.25	0.15	0.65	0.50	0.30	n/a	n/a	n/a	
9 (229)	0.65	0.61	0.57	0.70	0.60	0.49	0.59	0.57	0.55	0.40	0.30	0.18	0.70	0.59	0.36	n/a	n/a	n/a	
10 (254)	0.66	0.62	0.57	0.74	0.63	0.51	0.60	0.58	0.56	0.46	0.35	0.21	0.74	0.63	0.42	n/a	n/a	n/a	
11 (279)	0.68	0.64	0.58	0.79	0.67	0.53	0.61	0.59	0.56	0.54	0.40	0.24	0.79	0.67	0.48	n/a	n/a	n/a	
12 (305)	0.70	0.65	0.59	0.84	0.70	0.55	0.62	0.60	0.57	0.61	0.46	0.27	0.84	0.70	0.55	n/a	n/a	n/a	
12-7/8 (327)	0.71	0.66	0.60	0.88	0.73	0.56	0.63	0.61	0.58	0.68	0.51	0.31	0.88	0.73	0.56	0.72	n/a	n/a	
13 (330)	0.71	0.66	0.60	0.89	0.73	0.56	0.63	0.61	0.58	0.69	0.52	0.31	0.89	0.73	0.56	0.72	n/a	n/a	
14 (356)	0.73	0.67	0.60	0.94	0.77	0.58	0.64	0.62	0.58	0.77	0.58	0.35	0.94	0.77	0.58	0.75	n/a	n/a	
16 (406)	0.76	0.70	0.62	1.00	0.84	0.62	0.66	0.63	0.59	0.94	0.71	0.42	1.00	0.84	0.62	0.80	n/a	n/a	
16-1/4 (413)	0.77	0.70	0.62		0.85	0.63	0.66	0.63	0.60	0.96	0.72	0.43		0.85	0.63	0.81	0.73	n/a	
18 (457)	0.80	0.72	0.63		0.91	0.66	0.68	0.65	0.61	1.00	0.84	0.50		0.91	0.66	0.85	0.77	n/a	
20 (508)	0.83	0.75	0.65		0.99	0.70	0.70	0.67	0.62		0.99	0.59		0.99	0.70	0.89	0.81	n/a	
22 (559)	0.86	0.77	0.66		1.00	0.74	0.72	0.68	0.63		1.00	0.68		1.00	0.74	0.94	0.85	n/a	
24 (610)	0.90	0.80	0.68			0.78	0.74	0.70	0.64			0.78			0.78	0.98	0.89	n/a	
25-1/4 (641)	0.92	0.81	0.69			0.81	0.75	0.71	0.65			0.84			0.81	1.00	0.91	0.77	
26 (660)	0.93	0.82	0.69			0.82	0.76	0.71	0.65			0.88			0.82		0.93	0.78	
28 (711)	0.96	0.85	0.71			0.87	0.78	0.73	0.66			0.98			0.87		0.96	0.81	
30 (762)	0.99	0.87	0.72			0.91	0.80	0.75	0.68			1.00			0.91		1.00	0.84	
36 (914)	1.00	0.94	0.77			1.00	0.86	0.80	0.71						1.00			0.92	
>48 (1219)		1.00	0.86				0.98	0.90	0.78									1.00	

Footnotes for Tables 17 and 18

- Linear interpolation not permitted
- Shaded area with reduced edge distance is permitted provided rebar has no installation torque.
- When combining multiple load adjustment factors (e.g. for a four-anchor pattern in a corner with thin concrete member) the design can become very conservative. To optimize the design, use Hilti PROFIS Anchor Design software or perform anchor calculation using design equations from ACI 318-14 Chapter 17.
- Spacing factor reduction in shear, f_{AV}, assumes an influence of a nearby edge. If no edge exists, then f_{AV} = f_{AN}.
- Concrete thickness reduction factor in shear, f_{HV}, assumes an influence of a nearby edge. If no edge exists, then f_{HV} = 1.0.

Table 19 — Load adjustment factors for #10 rebar in uncracked concrete ^{1,2,3}

	#10 Uncracked Concrete	Spacing Factor in Tension			Edge Distance Factor in Tension			Spacing Factor in Shear ⁴			Edge Distance in Shear						Concrete Thickness Factor in Shear ⁵		
		f_{AN}			f_{RN}			f_{AV}			⊥ Toward Edge f_{RV}			∥ To Edge f_{RV}			f_{HV}		
		11-1/4 (286)	15 (381)	25 (635)	11-1/4 (286)	15 (381)	25 (635)	11-1/4 (286)	15 (381)	25 (635)	11-1/4 (286)	15 (381)	25 (635)	11-1/4 (286)	15 (381)	25 (635)	11-1/4 (286)	15 (381)	25 (635)
Spacing (s) / Edge Distance (c ₂) / Concrete Thickness (h) — in (mm)	Embedment h _{ef} in (mm)																		
	1-3/4 (44)	n/a	n/a	n/a	0.22	0.16	0.09	n/a	n/a	n/a	0.02	0.01	0.01	0.03	0.02	0.01	n/a	n/a	n/a
	6-1/4 (159)	0.59	0.57	0.54	0.32	0.24	0.14	0.54	0.53	0.52	0.11	0.08	0.05	0.22	0.16	0.10	n/a	n/a	n/a
	7 (178)	0.60	0.58	0.55	0.34	0.25	0.15	0.54	0.53	0.52	0.13	0.09	0.06	0.26	0.19	0.11	n/a	n/a	n/a
	8 (203)	0.62	0.59	0.55	0.37	0.27	0.16	0.55	0.54	0.53	0.16	0.12	0.07	0.31	0.23	0.14	n/a	n/a	n/a
	9 (229)	0.63	0.60	0.56	0.40	0.29	0.17	0.55	0.54	0.53	0.19	0.14	0.08	0.38	0.28	0.17	n/a	n/a	n/a
	10 (254)	0.65	0.61	0.57	0.43	0.32	0.18	0.56	0.55	0.54	0.22	0.16	0.10	0.43	0.32	0.18	n/a	n/a	n/a
	11 (279)	0.66	0.62	0.57	0.46	0.34	0.20	0.57	0.55	0.54	0.25	0.19	0.11	0.46	0.34	0.20	n/a	n/a	n/a
	12 (305)	0.68	0.63	0.58	0.49	0.36	0.21	0.57	0.56	0.54	0.29	0.21	0.13	0.49	0.36	0.21	n/a	n/a	n/a
	13 (330)	0.69	0.64	0.59	0.53	0.39	0.23	0.58	0.56	0.55	0.33	0.24	0.14	0.53	0.39	0.23	n/a	n/a	n/a
	14 (356)	0.71	0.66	0.59	0.57	0.42	0.24	0.59	0.57	0.55	0.36	0.27	0.16	0.57	0.42	0.24	n/a	n/a	n/a
	14-1/4 (362)	0.71	0.66	0.60	0.58	0.42	0.25	0.59	0.57	0.55	0.37	0.27	0.16	0.58	0.42	0.25	0.59	n/a	n/a
	15 (381)	0.72	0.67	0.60	0.61	0.45	0.26	0.59	0.57	0.55	0.40	0.30	0.18	0.61	0.45	0.26	0.60	n/a	n/a
	16 (406)	0.74	0.68	0.61	0.65	0.47	0.28	0.60	0.58	0.56	0.45	0.33	0.20	0.65	0.47	0.28	0.62	n/a	n/a
	17 (432)	0.75	0.69	0.61	0.69	0.50	0.30	0.60	0.58	0.56	0.49	0.36	0.21	0.69	0.50	0.30	0.64	n/a	n/a
	18 (457)	0.77	0.70	0.62	0.73	0.53	0.31	0.61	0.59	0.56	0.53	0.39	0.23	0.73	0.53	0.31	0.66	0.60	n/a
	20 (508)	0.80	0.72	0.63	0.81	0.59	0.35	0.62	0.60	0.57	0.62	0.46	0.27	0.81	0.59	0.35	0.70	0.63	n/a
	22 (559)	0.83	0.74	0.65	0.89	0.65	0.38	0.63	0.61	0.58	0.72	0.53	0.32	0.89	0.65	0.38	0.73	0.66	n/a
	24 (610)	0.86	0.77	0.66	0.97	0.71	0.42	0.65	0.62	0.58	0.82	0.60	0.36	0.97	0.71	0.42	0.76	0.69	n/a
	26 (660)	0.89	0.79	0.67	1.00	0.77	0.45	0.66	0.63	0.59	0.92	0.68	0.41	1.00	0.77	0.45	0.79	0.72	n/a
28 (711)	0.91	0.81	0.69		0.83	0.49	0.67	0.64	0.60	1.00	0.76	0.45		0.83	0.49	0.82	0.74	0.63	
30 (762)	0.94	0.83	0.70		0.89	0.52	0.68	0.65	0.61		0.84	0.50		0.89	0.52	0.85	0.77	0.65	
36 (914)	1.00	0.90	0.74		1.00	0.63	0.72	0.68	0.63		1.00	0.66		1.00	0.63	0.94	0.84	0.71	
>48 (1219)		1.00	0.82			0.83	0.79	0.74	0.67			1.00			0.83	1.00	0.97	0.82	

Table 20 — Load adjustment factors for #10 rebar in cracked concrete ^{1,2,3}

	#10 Cracked Concrete	Spacing Factor in Tension			Edge Distance Factor in Tension			Spacing Factor in Shear ⁴			Edge Distance in Shear						Concrete Thickness Factor in Shear ⁵		
		f_{AN}			f_{RN}			f_{AV}			⊥ Toward Edge f_{RV}			∥ To Edge f_{RV}			f_{HV}		
		11-1/4 (286)	15 (381)	25 (635)	11-1/4 (286)	15 (381)	25 (635)	11-1/4 (286)	15 (381)	25 (635)	11-1/4 (286)	15 (381)	25 (635)	11-1/4 (286)	15 (381)	25 (635)	11-1/4 (286)	15 (381)	25 (635)
Spacing (s) / Edge Distance (c ₂) / Concrete Thickness (h) — in (mm)	Embedment h _{ef} in (mm)																		
	1-3/4 (44)	n/a	n/a	n/a	0.40	0.39	0.37	n/a	n/a	n/a	0.03	0.02	0.01	0.06	0.04	0.03	n/a	n/a	n/a
	6-1/4 (159)	0.59	0.57	0.54	0.56	0.50	0.44	0.56	0.55	0.53	0.20	0.15	0.09	0.39	0.29	0.18	n/a	n/a	n/a
	7 (178)	0.60	0.58	0.55	0.58	0.52	0.45	0.56	0.55	0.54	0.23	0.17	0.10	0.46	0.35	0.21	n/a	n/a	n/a
	8 (203)	0.62	0.59	0.55	0.62	0.55	0.46	0.57	0.56	0.54	0.28	0.21	0.13	0.56	0.42	0.25	n/a	n/a	n/a
	9 (229)	0.63	0.60	0.56	0.66	0.57	0.48	0.58	0.57	0.55	0.34	0.25	0.15	0.66	0.51	0.30	n/a	n/a	n/a
	10 (254)	0.65	0.61	0.57	0.70	0.60	0.49	0.59	0.57	0.55	0.39	0.30	0.18	0.70	0.59	0.36	n/a	n/a	n/a
	11 (279)	0.66	0.62	0.57	0.74	0.63	0.51	0.60	0.58	0.56	0.46	0.34	0.20	0.74	0.63	0.41	n/a	n/a	n/a
	12 (305)	0.68	0.63	0.58	0.78	0.66	0.53	0.61	0.59	0.56	0.52	0.39	0.23	0.78	0.66	0.47	n/a	n/a	n/a
	13 (330)	0.69	0.64	0.59	0.82	0.69	0.54	0.62	0.60	0.57	0.59	0.44	0.26	0.82	0.69	0.53	n/a	n/a	n/a
	14 (356)	0.71	0.66	0.59	0.87	0.72	0.56	0.63	0.60	0.57	0.65	0.49	0.29	0.87	0.72	0.56	n/a	n/a	n/a
	14-1/4 (362)	0.71	0.66	0.60	0.88	0.73	0.56	0.63	0.61	0.58	0.67	0.50	0.30	0.88	0.73	0.56	0.71	n/a	n/a
	15 (381)	0.72	0.67	0.60	0.91	0.75	0.57	0.63	0.61	0.58	0.73	0.54	0.33	0.91	0.75	0.57	0.73	n/a	n/a
	16 (406)	0.74	0.68	0.61	0.96	0.78	0.59	0.64	0.62	0.58	0.80	0.60	0.36	0.96	0.78	0.59	0.76	n/a	n/a
	17 (432)	0.75	0.69	0.61	1.00	0.81	0.61	0.65	0.63	0.59	0.87	0.66	0.39	1.00	0.81	0.61	0.78	n/a	n/a
	18 (457)	0.77	0.70	0.62		0.85	0.62	0.66	0.63	0.59	0.95	0.71	0.43		0.85	0.62	0.80	0.73	n/a
	20 (508)	0.80	0.72	0.63		0.91	0.66	0.68	0.65	0.61	1.00	0.84	0.50		0.91	0.66	0.85	0.77	n/a
	22 (559)	0.83	0.74	0.65		0.98	0.69	0.70	0.66	0.62		0.97	0.58		0.98	0.69	0.89	0.81	n/a
	24 (610)	0.86	0.77	0.66		1.00	0.73	0.72	0.68	0.63		1.00	0.66		1.00	0.73	0.93	0.84	n/a
	26 (660)	0.89	0.79	0.67			0.77	0.73	0.69	0.64			0.74			0.77	0.97	0.88	n/a
28 (711)	0.91	0.81	0.69			0.81	0.75	0.71	0.65			0.83			0.81	1.00	0.91	0.77	
30 (762)	0.94	0.83	0.70			0.85	0.77	0.72	0.66			0.92			0.85		0.94	0.79	
36 (914)	1.00	0.90	0.74			0.97	0.82	0.77	0.69			1.00			0.97		1.00	0.87	
>48 (1219)		1.00	0.82			1.00	0.93	0.86	0.75						1.00			1.00	

Footnotes for Tables 19 and 20

- Linear interpolation not permitted
- Shaded area with reduced edge distance is permitted provided rebar has no installation torque.
- When combining multiple load adjustment factors (e.g. for a four-anchor pattern in a corner with thin concrete member) the design can become very conservative. To optimize the design, use Hilti PROFIS Anchor Design software or perform anchor calculation using design equations from ACI 318-14 Chapter 17.
- Spacing factor reduction in shear, f_{AV} , assumes an influence of a nearby edge. If no edge exists, then $f_{AV} = f_{AN}$.
- Concrete thickness reduction factor in shear, f_{HV} , assumes an influence of a nearby edge. If no edge exists, then $f_{HV} = 1.0$.

2.4.9 Hilti HIT-RE 100 Adhesive with Hilti HAS Threaded Rod

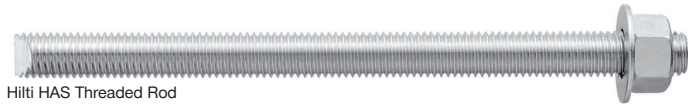

Permissible concrete conditions		Uncracked concrete		Dry Concrete		Water-filled holes	Permissible Drilling Method		Hammer drilling with carbide tipped drill bit
		Cracked concrete		Water-saturated concrete		Submerged (underwater)			Hilti TE-CD or TE-YD Hollow Drill Bit

Table 21 — Specifications for fractional threaded rod installed with HIT-RE 100 adhesive

Setting information		Symbol	Units	Nominal anchor diameter						
				3/8	1/2	5/8	3/4	7/8	1	1-1/4
Nominal bit diameter		d_o	in.	7/16	9/16	3/4	7/8	1	1-1/8	1-3/8
Standard effective embedment		$h_{ef, std}$	in. (mm)	3-3/8 (86)	4-1/2 (114)	5-5/8 (143)	6-3/4 (171)	7-7/8 (200)	9 (229)	11-1/4 (286)
Effective Embedment	minimum	$h_{ef, min}$	in. (mm)	2-3/8 (60)	2-3/4 (70)	3-1/8 (79)	3-1/2 (89)	3-1/2 (89)	4 (102)	5 (127)
	maximum	$h_{ef, max}$	in. (mm)	7-1/2 (191)	10 (254)	12-1/2 (318)	15 (381)	17-1/2 (445)	20 (508)	25 (635)
Minimum diameter of fixture hole	through-set		in.	1/2	5/8	13/16 ¹	15/16 ¹	1-1/8 ¹	1-1/4 ¹	1-1/2 ¹
	preset		in.	7/16	19/16	11/16	13/16	15/16	1-1/8	1-3/8
Installation torque		T_{inst}	ft-lb (Nm)	15 (20)	30 (40)	60 (80)	100 (136)	125 (169)	150 (203)	200 (271)
Minimum Concrete Thickness		h_{min}	in. (mm)	$h_{ef} + 1-1/4$ $(h_{ef} + 51)$			$h_{ef} + 2d_o$			
Minimum edge distance ²		c_{min}	in. (mm)	1-7/8 (48)	2-1/2 (64)	3-1/8 (79)	3-3/4 (95)	4-3/8 (111)	5 (127)	5-5/8 (143)
Minimum anchor spacing		s_{min}	in. (mm)	1-7/8 (48)	2-1/2 (64)	3-1/8 (79)	3-3/4 (95)	4-3/8 (111)	5 (127)	5-5/8 (143)

1 Install using (2) washers. See Figure 2.

2 Edge distance of 1-3/4-inch (44mm) is permitted provided the installation torque is reduced to 0.30 T_{inst} for 5d < s < 16-in. and to 0.5 T_{inst} for s > 16-in.

Figure 1 — HAS threaded rods

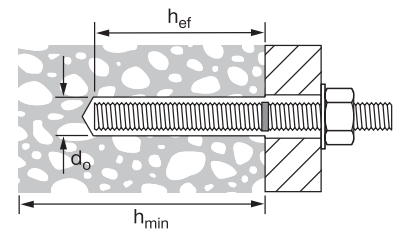

Figure 2 — Installation with (2) washers



Table 22 — Hilti HIT-RE 100 adhesive design strength with concrete / bond failure for fractional threaded rod in uncracked concrete ^{1,2,3,4,5,6,7,8,9,10}

Nominal Anchor Diameter in. (mm)	Nominal anchor diameter in. (mm)	Tension — ΦN_n				Shear — ΦV_n			
		$f'_c = 2500$ psi (17.2 MPa) lb (kN)	$f'_c = 3000$ psi (20.7 MPa) lb (kN)	$f'_c = 4000$ psi (27.6 MPa) lb (kN)	$f'_c = 6000$ psi (41.4 MPa) lb (kN)	$f'_c = 2500$ psi (17.2 MPa) lb (kN)	$f'_c = 3000$ psi (20.7 MPa) lb (kN)	$f'_c = 4000$ psi (27.6 MPa) lb (kN)	$f'_c = 6000$ psi (41.4 MPa) lb (kN)
3/8	2-3/8 (60)	1,955 (8.7)	1,995 (8.9)	2,050 (9.1)	2,135 (9.5)	2,490 (11.1)	2,535 (11.3)	2,610 (11.6)	2,720 (12.1)
	3-3/8 (86)	2,780 (12.4)	2,835 (12.6)	2,915 (13.0)	3,035 (13.5)	7,080 (31.5)	7,210 (32.1)	7,420 (33.0)	7,730 (34.4)
	4-1/2 (114)	3,710 (16.5)	3,775 (16.8)	3,885 (17.3)	4,050 (18.0)	9,440 (42.0)	9,615 (42.8)	9,895 (44.0)	10,305 (45.8)
	7-1/2 (191)	6,180 (27.5)	6,295 (28.0)	6,480 (28.8)	6,745 (30.0)	15,735 (70.0)	16,025 (71.3)	16,490 (73.4)	17,175 (76.4)
1/2	2-3/4 (70)	2,985 (13.3)	3,040 (13.5)	3,130 (13.9)	3,255 (14.5)	7,595 (33.8)	7,735 (34.4)	7,960 (35.4)	8,290 (36.9)
	4-1/2 (114)	4,885 (21.7)	4,975 (22.1)	5,120 (22.8)	5,330 (23.7)	12,430 (55.3)	12,660 (56.3)	13,030 (58.0)	13,565 (60.3)
	6 (152)	6,510 (29.0)	6,630 (29.5)	6,825 (30.4)	7,105 (31.6)	16,575 (73.7)	16,875 (75.1)	17,370 (77.3)	18,090 (80.5)
	10 (254)	10,850 (48.3)	11,050 (49.2)	11,375 (50.6)	11,845 (52.7)	27,620 (122.9)	28,130 (125.1)	28,950 (128.8)	30,150 (134.1)
5/8	3-1/8 (79)	4,065 (18.1)	4,140 (18.4)	4,260 (18.9)	4,435 (19.7)	9,280 (41.3)	10,165 (45.2)	10,840 (48.2)	11,290 (50.2)
	5-5/8 (143)	7,315 (32.5)	7,450 (33.1)	7,665 (34.1)	7,985 (35.5)	18,615 (82.8)	18,960 (84.3)	19,515 (86.8)	20,320 (90.4)
	7-1/2 (191)	9,750 (43.4)	9,930 (44.2)	10,220 (45.5)	10,645 (47.4)	24,825 (110.4)	25,280 (112.5)	26,015 (115.7)	27,095 (120.5)
	12-1/2 (318)	16,255 (72.3)	16,550 (73.6)	17,035 (75.8)	17,740 (78.9)	41,370 (184.0)	42,130 (187.4)	43,360 (192.9)	45,155 (200.9)
3/4	3-1/2 (89)	5,105 (22.7)	5,375 (23.9)	5,535 (24.6)	5,765 (25.6)	11,000 (48.9)	12,050 (53.6)	13,915 (61.9)	14,670 (65.3)
	6-3/4 (171)	10,180 (45.3)	10,370 (46.1)	10,670 (47.5)	11,115 (49.4)	25,920 (115.3)	26,395 (117.4)	27,165 (120.8)	28,290 (125.8)
	9 (229)	13,575 (60.4)	13,825 (61.5)	14,230 (63.3)	14,820 (65.9)	34,555 (153.7)	35,195 (156.6)	36,220 (161.1)	37,720 (167.8)
	15 (381)	22,625 (100.6)	23,045 (102.5)	23,715 (105.5)	24,695 (109.8)	57,595 (256.2)	58,655 (260.9)	60,365 (268.5)	62,865 (279.6)
7/8	3-1/2 (89)	5,105 (22.7)	5,595 (24.9)	6,235 (27.7)	6,490 (28.9)	11,000 (48.9)	12,050 (53.6)	13,915 (61.9)	16,525 (73.5)
	7-7/8 (200)	13,385 (59.5)	13,630 (60.6)	14,025 (62.4)	14,605 (65.0)	34,065 (151.5)	34,690 (154.3)	35,705 (158.8)	37,180 (165.4)
	10-1/2 (267)	17,845 (79.4)	18,170 (80.8)	18,700 (83.2)	19,475 (86.6)	45,420 (202.0)	46,255 (205.8)	47,605 (211.8)	49,575 (220.5)
	17-1/2 (445)	29,740 (132.3)	30,285 (134.7)	31,170 (138.7)	32,460 (144.4)	75,700 (336.7)	77,090 (342.9)	79,340 (352.9)	82,625 (367.5)
1	4 (102)	6,240 (27.8)	6,835 (30.4)	7,895 (35.1)	8,240 (36.7)	13,440 (59.8)	14,725 (65.5)	17,000 (75.6)	20,820 (92.6)
	9 (229)	16,980 (75.5)	17,295 (76.9)	17,800 (79.2)	18,535 (82.4)	43,225 (192.3)	44,020 (195.8)	45,305 (201.5)	47,180 (209.9)
	12 (305)	22,640 (100.7)	23,060 (102.6)	23,730 (105.6)	24,715 (109.9)	57,635 (256.4)	58,695 (261.1)	60,410 (268.7)	62,910 (279.8)
	20 (508)	37,735 (167.9)	38,430 (170.9)	39,555 (175.9)	41,190 (183.2)	96,055 (427.3)	97,825 (435.1)	100,680 (447.8)	104,845 (466.4)
1-1/4	5 (127)	8,720 (38.8)	9,555 (42.5)	11,030 (49.1)	12,355 (55.0)	18,785 (83.6)	20,575 (91.5)	23,760 (105.7)	29,100 (129.4)
	11-1/4 (286)	25,465 (113.3)	25,935 (115.4)	26,690 (118.7)	27,795 (123.6)	63,395 (282.0)	66,010 (293.6)	67,940 (302.2)	70,750 (314.7)
	15 (381)	33,955 (151.0)	34,575 (153.8)	35,585 (158.3)	37,060 (164.9)	86,425 (384.4)	88,015 (391.5)	90,585 (402.9)	94,335 (419.6)
	25 (635)	56,590 (251.7)	57,630 (256.3)	59,310 (263.8)	61,765 (274.7)	144,040 (640.7)	146,690 (652.5)	150,975 (671.6)	157,220 (699.3)

- See Section 3.1.8 (2019 PTG) for explanation on development of load values.
- See Section 3.1.8.6 (2019 PTG) to convert design strength value to ASD value.
- Linear interpolation between embedment depths and concrete compressive strengths is not permitted.
- Apply spacing, edge distance, and concrete thickness factors in tables 26-38 as necessary. Compare to the steel values in table 24 .
The lesser of the values is to be used for the design.
- Values are for the following temperature range: maximum short term temperature = 130°F (55°C), maximum long term temperature = 110°F (43°C).
Short term elevated concrete temperatures are those that occur over brief intervals, e.g., as a result of diurnal cycling. Long term concrete temperatures are roughly constant over significant periods of time.
- Tabular values are for dry concrete conditions. For water saturated concrete, water-filled drilled holes, or submerged (underwater) applications multiply design strength by 0.61.
- Tabular values are for short term loads only. For sustained loads including overhead use, see Section 3.1.8.8 (2019 PTG).
- Tabular values are for normal-weight concrete only. For lightweight concrete multiply design strength by λ_n as follows:
For sand-lightweight, $\lambda_n = 0.51$. For all-lightweight, $\lambda_n = 0.45$.
- Tabular values are for holes drilled in concrete with carbide tipped hammer drill bit. Diamond core drilling is not permitted.
- Tabular values are for static loads only. Seismic design is not permitted for uncracked concrete.

Table 23 — Hilti HIT-RE 100 adhesive design strength with concrete / bond failure for threaded rod in cracked concrete ^{1,2,3,4,5,6,7,8,9,10}

Nominal anchor diameter in. (mm)	Effective Embedment Depth in. (mm)	Tension — ΦN_n				Shear — ΦV_n			
		$f'_c = 2500$ psi (17.2 MPa) lb (kN)	$f'_c = 3000$ psi (20.7 MPa) lb (kN)	$f'_c = 4000$ psi (27.6 MPa) lb (kN)	$f'_c = 6000$ psi (41.4 MPa) lb (kN)	$f'_c = 2500$ psi (17.2 MPa) lb (kN)	$f'_c = 3000$ psi (20.7 MPa) lb (kN)	$f'_c = 4000$ psi (27.6 MPa) lb (kN)	$f'_c = 6000$ psi (41.4 MPa) lb (kN)
3/8	2-3/8 (60)	950 (4.2)	965 (4.3)	995 (4.4)	1,035 (4.6)	1,205 (5.4)	1,230 (5.5)	1,265 (5.6)	1,315 (5.8)
	3-3/8 (86)	1,345 (6.0)	1,370 (6.1)	1,410 (6.3)	1,470 (6.5)	3,430 (15.3)	3,490 (15.5)	3,595 (16.0)	3,745 (16.7)
	4-1/2 (114)	1,795 (8.0)	1,830 (8.1)	1,885 (8.4)	1,960 (8.7)	4,570 (20.3)	4,655 (20.7)	4,790 (21.3)	4,990 (22.2)
	7-1/2 (191)	2,995 (13.3)	3,050 (13.6)	3,140 (14.0)	3,265 (14.5)	7,620 (33.9)	7,760 (34.5)	7,985 (35.5)	8,315 (37.0)
1/2	2-3/4 (70)	1,405 (6.2)	1,430 (6.4)	1,475 (6.6)	1,535 (6.8)	3,580 (15.9)	3,645 (16.2)	3,750 (16.7)	3,910 (17.4)
	4-1/2 (114)	2,300 (10.2)	2,345 (10.4)	2,410 (10.7)	2,510 (11.2)	5,860 (26.1)	5,965 (26.5)	6,140 (27.3)	6,395 (28.4)
	6 (152)	3,070 (13.7)	3,125 (13.9)	3,215 (14.3)	3,350 (14.9)	7,810 (34.7)	7,955 (35.4)	8,185 (36.4)	8,525 (37.9)
	10 (254)	5,115 (22.8)	5,210 (23.2)	5,360 (23.8)	5,580 (24.8)	13,020 (57.9)	13,260 (59.0)	13,645 (60.7)	14,210 (63.2)
5/8	3-1/8 (79)	2,000 (8.9)	2,035 (9.1)	2,095 (9.3)	2,180 (9.7)	5,085 (22.6)	5,180 (23.0)	5,330 (23.7)	5,550 (24.7)
	5-5/8 (143)	3,595 (16.0)	3,660 (16.3)	3,770 (16.8)	3,925 (17.5)	9,155 (40.7)	9,320 (41.5)	9,595 (42.7)	9,990 (44.4)
	7-1/2 (191)	4,795 (21.3)	4,885 (21.7)	5,025 (22.4)	5,235 (23.3)	12,205 (54.3)	12,430 (55.3)	12,790 (56.9)	13,320 (59.3)
	12-1/2 (318)	7,990 (35.5)	8,140 (36.2)	8,375 (37.3)	8,725 (38.8)	20,340 (90.5)	20,715 (92.1)	21,320 (94.8)	22,205 (98.8)
3/4	3-1/2 (89)	2,540 (11.3)	2,585 (11.5)	2,660 (11.8)	2,770 (12.3)	6,465 (28.8)	6,585 (29.3)	6,775 (30.1)	7,055 (31.4)
	6-3/4 (171)	4,900 (21.8)	4,990 (22.2)	5,135 (22.8)	5,345 (23.8)	12,470 (55.5)	12,700 (56.5)	13,070 (58.1)	13,610 (60.5)
	9 (229)	6,530 (29.0)	6,650 (29.6)	6,845 (30.4)	7,130 (31.7)	16,625 (74.0)	16,930 (75.3)	17,425 (77.5)	18,145 (80.7)
	15 (381)	10,885 (48.4)	11,085 (49.3)	11,410 (50.8)	11,880 (52.8)	27,710 (123.3)	28,220 (125.5)	29,040 (129.2)	30,245 (134.5)
7/8	3-1/2 (89)	2,730 (12.1)	2,780 (12.4)	2,860 (12.7)	2,980 (13.3)	6,950 (30.9)	7,080 (31.5)	7,285 (32.4)	7,585 (33.7)
	7-7/8 (200)	6,145 (27.3)	6,255 (27.8)	6,440 (28.6)	6,705 (29.8)	15,640 (69.6)	15,925 (70.8)	16,390 (72.9)	17,070 (75.9)
	10-1/2 (267)	8,190 (36.4)	8,340 (37.1)	8,585 (38.2)	8,940 (39.8)	20,850 (92.7)	21,235 (94.5)	21,855 (97.2)	22,760 (101.2)
	17-1/2 (445)	13,650 (60.7)	13,905 (61.9)	14,310 (63.7)	14,900 (66.3)	34,750 (154.6)	35,390 (157.4)	36,425 (162.0)	37,930 (168.7)
1	4 (102)	3,320 (14.8)	3,380 (15.0)	3,475 (15.5)	3,620 (16.1)	8,445 (37.6)	8,600 (38.3)	8,850 (39.4)	9,215 (41.0)
	9 (229)	7,465 (33.2)	7,600 (33.8)	7,825 (34.8)	8,145 (36.2)	19,000 (84.5)	19,350 (86.1)	19,915 (88.6)	20,740 (92.3)
	12 (305)	9,955 (44.3)	10,135 (45.1)	10,430 (46.4)	10,865 (48.3)	25,335 (112.7)	25,800 (114.8)	26,555 (118.1)	27,650 (123.0)
	20 (508)	16,590 (73.8)	16,895 (75.2)	17,385 (77.3)	18,105 (80.5)	42,225 (187.8)	43,000 (191.3)	44,255 (196.9)	46,085 (205.0)
1-1/4	5 (127)	4,405 (19.6)	4,485 (20.0)	4,620 (20.6)	4,810 (21.4)	11,215 (49.9)	11,420 (50.8)	11,755 (52.3)	12,240 (54.4)
	11-1/4 (286)	9,915 (44.1)	10,095 (44.9)	10,390 (46.2)	10,820 (48.1)	25,235 (112.3)	25,700 (114.3)	26,450 (117.7)	27,545 (122.5)
	15 (381)	13,220 (58.8)	13,460 (59.9)	13,855 (61.6)	14,430 (64.2)	33,645 (149.7)	34,265 (152.4)	35,265 (156.9)	36,725 (163.4)
	25 (635)	22,030 (98.0)	22,435 (99.8)	23,090 (102.7)	24,045 (107.0)	56,075 (249.4)	57,110 (254.0)	58,775 (261.4)	61,210 (272.3)

- See Section 3.1.8 (2019 PTG) for explanation on development of load values.
- See Section 3.1.8.6 (2019 PTG) to convert design strength value to ASD value.
- Linear interpolation between embedment depths and concrete compressive strengths is not permitted.
- Apply spacing, edge distance, and concrete thickness factors in tables 5-20 as necessary. Compare to the steel values in table 24. The lesser of the values is to be used for the design.
- Values are for the following temperature range: maximum short term temperature = 130°F (55°C), maximum long term temperature = 110°F (43°C). Short term elevated concrete temperatures are those that occur over brief intervals, e.g., as a result of diurnal cycling. Long term concrete temperatures are roughly constant over significant periods of time.
- Tabular values are for dry concrete conditions. For water saturated concrete, water-filled drilled holes, or submerged (underwater) applications multiply design strength by 0.61.
- Tabular values are for short term loads only. For sustained loads including overhead use, see Section 3.1.8.8 (2019 PTG).
- Tabular values are for normal-weight concrete only. For lightweight concrete multiply design strength by λ_n as follows:
For sand-lightweight, $\lambda_n = 0.51$. For all-lightweight, $\lambda_n = 0.45$.
- Tabular values are for holes drilled in concrete with carbide tipped hammer drill bit. Diamond core drilling is not permitted.
- Tabular values are for static loads only. For seismic loads, multiply cracked concrete tabular values in tension and shear by $\alpha_{\text{seis}} = 0.675$. See section 3.1.8.7 (2019 PTG) for additional information on seismic applications

Table 24 — Steel design strength for Hilti HIT-V and HAS threaded rods ¹

Nominal anchor diameter in. (mm)	HAS-E ISO 898 Class 5.8 ^{2,7}			HAS-E-B7 ASTM A193 B7 ³			HAS-R stainless steel ASTM F 593 - AISI 304/316 SS ²		
	Tensile ⁴	Shear ⁵	Seismic Shear ⁶	Tensile ⁴	Shear ⁵	Seismic Shear ⁶	Tensile ⁴	Shear ⁵	Seismic Shear ⁶
	ϕN_{sa} lb (kN)	ϕV_{sa} lb (kN)	$\phi V_{sa,eq}$ lb (kN)	ϕN_{sa} lb (kN)	ϕV_{sa} lb (kN)	$\phi V_{sa,eq}$ lb (kN)	ϕN_{sa} lb (kN)	ϕV_{sa} lb (kN)	$\phi V_{sa,eq}$ lb (kN)
3/8	3,655 (16.3)	2,020 (9.0)	1,415 (6.3)	7,265 (32.3)	3,775 (16.8)	2,645 (11.8)	5,040 (22.4)	2,790 (12.4)	1,955 (8.7)
1/2	6,690 (29.8)	3,705 (16.5)	2,595 (11.5)	13,300 (59.2)	6,915 (30.8)	4,840 (21.5)	9,225 (41.0)	5,110 (22.7)	3,575 (15.9)
5/8	10,650 (47.4)	5,900 (26.2)	4,130 (18.4)	21,190 (94.3)	11,020 (49.0)	7,715 (34.3)	14,690 (65.3)	8,135 (36.2)	5,695 (25.3)
3/4	15,765 (70.1)	8,730 (38.8)	6,110 (27.2)	31,360 (139.5)	16,305 (72.5)	11,415 (50.8)	18,480 (82.2)	10,235 (45.5)	7,165 (31.9)
7/8	21,755 (96.8)	12,050 (53.6)	8,435 (37.5)	43,285 (192.5)	22,505 (100.1)	15,755 (70.1)	25,510 (113.5)	14,125 (62.8)	9,890 (44.0)
1	28,540 (127.0)	15,805 (70.3)	11,065 (49.2)	56,785 (252.6)	29,525 (131.3)	20,670 (91.9)	33,465 (148.9)	18,535 (82.4)	12,975 (57.7)
1-1/4	45,670 (203.1)	25,295 (112.5)	17,705 (78.8)	90,850 (404.1)	47,240 (210.1)	33,070 (147.1)	53,540 (238.2)	29,655 (131.9)	20,760 (92.3)

- 1 See Section 3.1.8 (2019 PTG) to convert design strength value to ASD value.
- 2 HAS-E and HAS-R threaded rods are considered brittle steel elements.
- 3 HAS-E-B7 rods are considered ductile steel elements.
- 4 Tensile = $\phi A_{se,N} f_{uts}$ as noted in ACI 318-14 Chapter 17
- 5 Shear = $\phi 0.60 A_{se,V} f_{uts}$ as noted in ACI 318-14 Chapter 17. For 3/8-in diameter threaded rod, shear = $\phi 0.50 A_{se,V} f_{uts}$
- 6 Seismic Shear = $\alpha_{v,seis} \phi V_{sa}$; Reduction factor for seismic shear only.
- 7 HAS-E does not comply with % elongation requirements of ISO 898-1.

Table 25 — Steel factored resistance for Hilti HAS threaded rods for use with CSA A23.3-14 Annex D



Nominal anchor diameter in.	HAS-V-36 / HAS-V-36 HDG ASTM F1554 Gr.36 ^{4,6}			HAS-E-55 / HAS-E-55 HDG ASTM F1554 Gr. 55 ^{4,6}			HAS-B-105 / HAS-B-105 HDG ASTM A193 B7 and ASTM F 1554 Gr.105 ^{4,6}			HAS-R stainless steel ASTM F593 (3/8-in to 1-in) ⁵ ASTM A193 (1-1/8-in to 2-in) ⁴		
	Tensile ¹ ϕN_{sar} lb (kN)	Shear ² ϕV_{sar} lb (kN)	Seismic Shear ³ $\phi V_{sar,eq}$ lb (kN)	Tensile ¹ ϕN_{sar} lb (kN)	Shear ² ϕV_{sar} lb (kN)	Seismic Shear ³ $\phi V_{sar,eq}$ lb (kN)	Tensile ¹ ϕN_{sar} lb (kN)	Shear ² ϕV_{sar} lb (kN)	Seismic Shear ³ $\phi V_{sar,eq}$ lb (kN)	Tensile ¹ ϕN_{sar} lb (kN)	Shear ² ϕV_{sar} lb (kN)	Seismic Shear ³ $\phi V_{sar,eq}$ lb (kN)
3/8	3,055 (13.6)	1,720 (7.7)	1,030 (4.6)	3,955 (17.6)	2,225 (9.9)	1,560 (6.9)	6,570 (29.2)	3,695 (16.4)	2,585 (11.5)	4,610 (20.5)	2,570 (11.4)	1,800 (8.0)
1/2	5,595 (24.9)	3,150 (14.0)	1,890 (8.4)	7,240 (32.2)	4,070 (18.1)	2,850 (12.7)	12,035 (53.5)	6,765 (30.1)	4,735 (21.1)	8,445 (37.6)	4,705 (20.9)	3,295 (14.7)
5/8	8,915 (39.7)	5,015 (22.3)	3,010 (13.4)	11,525 (51.3)	6,485 (28.8)	4,540 (20.2)	19,160 (85.2)	10,780 (48.0)	7,545 (33.6)	13,445 (59.8)	7,490 (33.3)	5,245 (23.3)
3/4	13,190 (58.7)	7,420 (33.0)	4,450 (19.8)	17,060 (75.9)	9,600 (42.7)	6,720 (29.9)	28,365 (126.2)	15,955 (71.0)	11,170 (49.7)	16,920 (75.3)	9,425 (41.9)	6,600 (29.4)
7/8	18,210 (81.0)	10,245 (45.6)	6,145 (27.3)	23,550 (104.8)	13,245 (58.9)	9,270 (41.2)	39,150 (174.1)	22,020 (97.9)	15,415 (68.6)	23,350 (103.9)	13,010 (57.9)	9,105 (40.5)
1	23,890 (106.3)	13,440 (59.8)	8,065 (35.9)	30,890 (137.4)	17,380 (77.3)	12,165 (54.1)	51,360 (228.5)	28,890 (128.5)	20,225 (90.0)	30,635 (136.3)	17,065 (75.9)	11,945 (53.1)
1-1/4	38,225 (170.0)	21,500 (95.6)	12,900 (57.4)	49,425 (219.9)	27,800 (123.7)	19,460 (86.6)	82,175 (365.5)	46,220 (205.6)	32,355 (143.9)	37,565 (167.1)	21,130 (94.0)	12,680 (56.4)

- 1 Tensile = $A_{se,N} \phi f_{uts} R$ as noted in CSA A23.3-14 Eq. D.2.
- 2 Shear = $A_{se,V} \phi 0.60 f_{uts} R$ as noted in CSA A23.3-14 Eq. D.31.
- 3 Seismic Shear = $\alpha_{v,seis} V_{sar}$; Reduction factor for seismic shear only. See CSA A23.3 Annex D for additional information on seismic applications.
- 4 HAS-V, HAS-E (3/8-in to 1-1/4-in), HAS-B, and HAS-R (Class 1; 1-1/4-in) threaded rods are considered ductile steel elements (including HDG rods).
- 5 HAS-R (CW1 and CW2; 3/8-in to 1-in) threaded rods are considered brittle steel elements.
- 6 3/8-inch dia. threaded rods are not included in the ASTM F1554 standard. Hilti 3/8-inch dia. HAS-V, HAS-E, and HAS-E-B (incl. HDG) threaded rods meet the chemical composition and mechanical property requirements of ASTM F1554.

Table 26 — Load adjustment factors for 3/8-in. diameter fractional threaded rods in uncracked concrete ^{1,2,3}

3/8 in Uncracked Concrete	Spacing Factor in Tension f_{AN}				Edge Distance Factor in Tension f_{RN}				Spacing Factor in Shear ⁴ f_{AV}				Edge Distance in Shear								Conc. Thickness Factor in Shear ⁵ f_{HV}			
	Toward Edge f_{RV}		To Edge f_{RV}		Toward Edge f_{RV}		To Edge f_{RV}		Toward Edge f_{RV}		To Edge f_{RV}		Toward Edge f_{RV}		To Edge f_{RV}		Toward Edge f_{RV}		To Edge f_{RV}		Toward Edge f_{RV}		To Edge f_{RV}	
Embedment h_{ef} in (mm)	2-3/8 (60)	3-3/8 (86)	4-1/2 (114)	7-1/2 (191)	2-3/8 (60)	3-3/8 (86)	4-1/2 (114)	7-1/2 (191)	2-3/8 (60)	3-3/8 (86)	4-1/2 (114)	7-1/2 (191)	2-3/8 (60)	3-3/8 (86)	4-1/2 (114)	7-1/2 (191)	2-3/8 (60)	3-3/8 (86)	4-1/2 (114)	7-1/2 (191)	2-3/8 (60)	3-3/8 (86)	4-1/2 (114)	7-1/2 (191)
1-3/4 (44)	n/a	n/a	n/a	n/a	0.43	0.32	0.23	0.13	n/a	n/a	n/a	n/a	0.28	0.10	0.08	0.05	0.43	0.21	0.16	0.09	n/a	n/a	n/a	n/a
1-7/8 (48)	0.61	0.59	0.57	0.54	0.45	0.33	0.24	0.14	0.58	0.54	0.53	0.52	0.31	0.12	0.09	0.05	0.45	0.23	0.17	0.10	n/a	n/a	n/a	n/a
2 (51)	0.62	0.60	0.57	0.54	0.47	0.34	0.25	0.14	0.58	0.54	0.53	0.52	0.34	0.13	0.10	0.06	0.47	0.25	0.19	0.11	n/a	n/a	n/a	n/a
3 (76)	0.68	0.65	0.61	0.57	0.60	0.42	0.31	0.18	0.62	0.56	0.55	0.54	0.63	0.23	0.18	0.11	0.60	0.42	0.31	0.18	n/a	n/a	n/a	n/a
3-5/8 (92)	0.72	0.68	0.63	0.58	0.70	0.48	0.35	0.20	0.65	0.58	0.56	0.54	0.84	0.31	0.23	0.14	0.70	0.48	0.35	0.20	0.77	n/a	n/a	n/a
4 (102)	0.74	0.70	0.65	0.59	0.77	0.52	0.38	0.22	0.66	0.58	0.57	0.55	0.98	0.36	0.27	0.16	0.77	0.52	0.38	0.22	0.81	n/a	n/a	n/a
4-5/8 (117)	0.77	0.73	0.67	0.60	0.89	0.60	0.43	0.25	0.69	0.60	0.58	0.56	1.00	0.45	0.34	0.20	0.89	0.60	0.43	0.25	0.87	0.62	n/a	n/a
5 (127)	0.80	0.75	0.69	0.61	0.96	0.64	0.47	0.27	0.70	0.61	0.59	0.56		0.50	0.38	0.23	0.96	0.64	0.47	0.27	0.91	0.65	n/a	n/a
5-3/4 (146)	0.84	0.78	0.71	0.63	1.00	0.74	0.54	0.31	0.74	0.62	0.60	0.57		0.62	0.46	0.28	1.00	0.74	0.54	0.31	0.97	0.70	0.63	n/a
6 (152)	0.86	0.80	0.72	0.63		0.77	0.56	0.33	0.75	0.63	0.60	0.57		0.66	0.50	0.30		0.77	0.56	0.33	0.99	0.71	0.65	n/a
7 (178)	0.92	0.85	0.76	0.66		0.90	0.66	0.38	0.79	0.65	0.62	0.59		0.83	0.62	0.37		0.90	0.66	0.38	1.00	0.77	0.70	n/a
8 (203)	0.97	0.90	0.80	0.68		1.00	0.75	0.43	0.83	0.67	0.64	0.60		1.00	0.76	0.46		1.00	0.75	0.43		0.82	0.75	n/a
8-3/4 (222)	1.00	0.93	0.82	0.69			0.82	0.48	0.86	0.68	0.65	0.61			0.87	0.52			0.82	0.48		0.86	0.78	0.66
9 (229)		0.94	0.83	0.70			0.84	0.49	0.87	0.69	0.66	0.61			0.91	0.55			0.84	0.49		0.87	0.79	0.67
10 (254)		0.99	0.87	0.72			0.94	0.54	0.91	0.71	0.67	0.62			1.00	0.64			0.94	0.54		0.92	0.83	0.70
11 (279)		1.00	0.91	0.74			1.00	0.60	0.95	0.73	0.69	0.64				0.74			1.00	0.60		0.96	0.87	0.74
12 (305)			0.94	0.77				0.65	0.99	0.75	0.71	0.65				0.84				0.65		1.00	0.91	0.77
14 (356)			1.00	0.81				0.76	1.00	0.80	0.74	0.67										1.00	0.99	0.83
16 (406)				0.86				0.87		0.84	0.78	0.70											1.00	0.89
18 (457)				0.90				0.98		0.88	0.81	0.72												0.94
24 (610)				1.00				1.00		1.00	0.92	0.80												1.00
30 (762)											1.00	0.87												
36 (914)												0.95												
>48 (1219)												1.00												

Table 27 — Load adjustment factors for 3/8-in. diameter fractional threaded rods in cracked concrete ^{1,2,3}

3/8 in Cracked Concrete	Spacing Factor in Tension f_{AN}				Edge Distance Factor in Tension f_{RN}				Spacing Factor in Shear ⁴ f_{AV}				Edge Distance in Shear								Conc. Thickness Factor in Shear ⁵ f_{HV}			
	Toward Edge f_{RV}		To Edge f_{RV}		Toward Edge f_{RV}		To Edge f_{RV}		Toward Edge f_{RV}		To Edge f_{RV}		Toward Edge f_{RV}		To Edge f_{RV}		Toward Edge f_{RV}		To Edge f_{RV}		Toward Edge f_{RV}		To Edge f_{RV}	
Embedment h_{ef} in (mm)	2-3/8 (60)	3-3/8 (86)	4-1/2 (114)	7-1/2 (191)	2-3/8 (60)	3-3/8 (86)	4-1/2 (114)	7-1/2 (191)	2-3/8 (60)	3-3/8 (86)	4-1/2 (114)	7-1/2 (191)	2-3/8 (60)	3-3/8 (86)	4-1/2 (114)	7-1/2 (191)	2-3/8 (60)	3-3/8 (86)	4-1/2 (114)	7-1/2 (191)	2-3/8 (60)	3-3/8 (86)	4-1/2 (114)	7-1/2 (191)
1-3/4 (44)	n/a	n/a	n/a	n/a	0.58	0.54	0.49	0.43	n/a	n/a	n/a	n/a	0.42	0.15	0.12	0.07	0.58	0.31	0.23	0.14	n/a	n/a	n/a	n/a
1-7/8 (48)	0.61	0.59	0.57	0.54	0.60	0.56	0.50	0.44	0.60	0.55	0.54	0.53	0.46	0.17	0.13	0.08	0.60	0.34	0.26	0.15	n/a	n/a	n/a	n/a
2 (51)	0.62	0.60	0.57	0.54	0.62	0.57	0.51	0.44	0.61	0.55	0.55	0.53	0.51	0.19	0.14	0.08	0.62	0.38	0.28	0.17	n/a	n/a	n/a	n/a
3 (76)	0.68	0.65	0.61	0.57	0.78	0.70	0.60	0.49	0.66	0.58	0.57	0.55	0.93	0.34	0.26	0.16	0.78	0.69	0.52	0.31	n/a	n/a	n/a	n/a
3-5/8 (92)	0.72	0.68	0.63	0.58	0.89	0.78	0.66	0.53	0.69	0.60	0.58	0.56	1.00	0.46	0.34	0.21	0.89	0.78	0.66	0.41	0.88	n/a	n/a	n/a
4 (102)	0.74	0.70	0.65	0.59	0.96	0.84	0.70	0.55	0.71	0.61	0.59	0.56		0.53	0.40	0.24	0.96	0.84	0.70	0.48	0.92	n/a	n/a	n/a
4-5/8 (117)	0.77	0.73	0.67	0.60	1.00	0.93	0.76	0.58	0.75	0.63	0.60	0.57		0.66	0.49	0.30	1.00	0.93	0.76	0.58	0.99	0.71	n/a	n/a
5 (127)	0.80	0.75	0.69	0.61		0.99	0.80	0.60	0.77	0.64	0.61	0.58		0.74	0.56	0.33		0.99	0.80	0.60	1.00	0.74	n/a	n/a
5-3/4 (146)	0.84	0.78	0.71	0.63		1.00	0.88	0.64	0.81	0.66	0.63	0.59		0.91	0.69	0.41		1.00	0.88	0.64		0.79	0.72	n/a
6 (152)	0.86	0.80	0.72	0.63			0.91	0.66	0.82	0.66	0.64	0.60		0.97	0.73	0.44			0.91	0.66		0.81	0.74	n/a
7 (178)	0.92	0.85	0.76	0.66			1.00	0.72	0.87	0.69	0.66	0.61		1.00	0.92	0.55			1.00	0.72		0.87	0.79	n/a
8 (203)	0.97	0.90	0.80	0.68				0.78	0.92	0.72	0.68	0.63			1.00	0.68				0.78		0.93	0.85	n/a
8-3/4 (222)	1.00	0.93	0.82	0.69				0.83	0.96	0.74	0.70	0.64				0.77				0.83		0.98	0.89	0.75
9 (229)		0.94	0.83	0.70				0.85	0.98	0.75	0.70	0.64				0.81				0.85		0.99	0.90	0.76
10 (254)		0.99	0.87	0.72				0.91	1.00	0.77	0.73	0.66				0.94				0.91		1.00	0.95	0.80
11 (279)		1.00	0.91	0.74				0.98		0.80	0.75	0.68								0.98			1.00	0.84
12 (305)			0.94	0.77				1.00		0.83	0.77	0.69								1.00				0.88
14 (356)			1.00	0.81						0.88	0.82	0.72												0.95
16 (406)				0.86						0.94	0.86	0.76												1.00
18 (457)				0.90						0.99	0.91	0.79												
24 (610)				1.00						1.00	1.00	0.88												
30 (762)												0.98												
36 (914)												1.00												
>48 (1219)																								

Footnotes for Tables 26 and 27

- Linear interpolation not permitted
- Shaded area with reduced edge distance is permitted provided the installation torque is reduced to 0.30 T_{max} for 5d < s < 16-in. and to 0.5 T_{max} for s > 16-in.
- When combining multiple load adjustment factors (e.g. for a four-anchor pattern in a corner with thin concrete member) the design can become very conservative. To optimize the design, use Hilti PROFIS Anchor Design software or perform anchor calculation using design equations from ACI 318-14 Chapter 17 and CSA A23.3-14 Annex D.
- Spacing factor reduction in shear, f_{AV} , assumes an influence of a nearby edge. If no edge exists, then $f_{AV} = f_{AN}$.
- Concrete thickness reduction factor in shear, f_{HV} , assumes an influence of a nearby edge. If no edge exists, then $f_{HV} = 1.0$.

Table 28 — Load adjustment factors for 1/2-in. diameter fractional threaded rods in uncracked concrete ^{1,2,3}

Embedment h_{ef} in (mm)	Spacing Factor in Tension f_{AN}				Edge Distance Factor in Tension f_{RN}				Spacing Factor in Shear ⁴ f_{AV}				Edge Distance in Shear								Conc. Thickness Factor in Shear ⁵ f_{HV}			
	Toward Edge f_{RV}		To Edge f_{RV}		Toward Edge f_{RV}		To Edge f_{RV}		Toward Edge f_{RV}		To Edge f_{RV}		Toward Edge f_{RV}		To Edge f_{RV}		Toward Edge f_{RV}		To Edge f_{RV}					
	2-3/4 (70)	4-1/2 (114)	6 (152)	10 (254)	2-3/4 (70)	4-1/2 (114)	6 (152)	10 (254)	2-3/4 (70)	4-1/2 (114)	6 (152)	10 (254)	2-3/4 (70)	4-1/2 (114)	6 (152)	10 (254)	2-3/4 (70)	4-1/2 (114)	6 (152)	10 (254)	2-3/4 (70)	4-1/2 (114)	6 (152)	10 (254)
1-3/4 (44)	n/a	n/a	n/a	n/a	0.40	0.27	0.20	0.12	n/a	n/a	n/a	n/a	0.10	0.07	0.05	0.03	0.21	0.14	0.10	0.06	n/a	n/a	n/a	n/a
2-1/2 (64)	0.61	0.59	0.57	0.54	0.48	0.32	0.23	0.14	0.55	0.54	0.53	0.52	0.18	0.12	0.09	0.05	0.35	0.23	0.18	0.11	n/a	n/a	n/a	n/a
3 (76)	0.63	0.61	0.58	0.55	0.53	0.35	0.26	0.15	0.56	0.55	0.54	0.53	0.23	0.15	0.12	0.07	0.47	0.31	0.23	0.14	n/a	n/a	n/a	n/a
4 (102)	0.68	0.65	0.61	0.57	0.66	0.41	0.30	0.18	0.58	0.56	0.55	0.54	0.36	0.24	0.18	0.11	0.66	0.41	0.30	0.18	0.58	n/a	n/a	n/a
5 (127)	0.72	0.69	0.64	0.58	0.82	0.48	0.35	0.21	0.61	0.58	0.57	0.55	0.50	0.33	0.25	0.15	0.82	0.48	0.35	0.21	0.65	n/a	n/a	n/a
5-3/4 (146)	0.76	0.71	0.66	0.60	0.94	0.54	0.40	0.23	0.62	0.59	0.58	0.55	0.62	0.41	0.31	0.18	0.94	0.54	0.40	0.23	0.70	0.61	n/a	n/a
6 (152)	0.77	0.72	0.67	0.60	0.98	0.57	0.42	0.24	0.63	0.60	0.58	0.56	0.66	0.43	0.33	0.20	0.98	0.57	0.42	0.24	0.71	0.62	n/a	n/a
7 (178)	0.81	0.76	0.69	0.62	1.00	0.66	0.48	0.28	0.65	0.61	0.59	0.57	0.83	0.55	0.41	0.25	1.00	0.66	0.48	0.28	0.77	0.67	n/a	n/a
7-1/4 (184)	0.82	0.77	0.70	0.62	0.68	0.50	0.29	0.65	0.62	0.60	0.57	0.57	0.88	0.58	0.43	0.26	0.68	0.50	0.29	0.68	0.78	0.68	0.62	n/a
8 (203)	0.86	0.80	0.72	0.63	0.75	0.55	0.32	0.67	0.63	0.61	0.57	0.57	1.00	0.67	0.50	0.30	0.75	0.55	0.32	0.67	0.82	0.71	0.65	n/a
9 (229)	0.90	0.83	0.75	0.65	0.85	0.62	0.36	0.69	0.64	0.62	0.58	0.58	0.80	0.60	0.36	0.36	0.85	0.62	0.36	0.36	0.87	0.76	0.69	n/a
10 (254)	0.95	0.87	0.78	0.67	0.94	0.69	0.40	0.71	0.66	0.63	0.59	0.59	0.94	0.70	0.42	0.42	0.94	0.69	0.40	0.40	0.92	0.80	0.73	n/a
11-1/4 (286)	1.00	0.92	0.81	0.69	1.00	0.78	0.46	0.74	0.68	0.65	0.61	0.61	1.00	0.84	0.50	0.50	1.00	0.78	0.46	0.46	0.97	0.85	0.77	0.65
12 (305)	0.94	0.83	0.70	0.70	0.83	0.49	0.75	0.69	0.66	0.66	0.61	0.61	0.92	0.55	0.55	0.55	0.83	0.49	0.75	0.69	1.00	0.87	0.79	0.67
14 (356)	1.00	0.89	0.73	0.73	0.97	0.57	0.79	0.72	0.68	0.63	0.63	0.63	1.00	0.70	0.70	0.70	0.97	0.57	0.73	0.73	1.00	0.94	0.86	0.72
16 (406)	0.94	0.77	0.77	0.77	1.00	0.65	0.84	0.76	0.71	0.65	0.65	0.65	0.85	0.85	0.85	0.85	1.00	0.65	0.65	0.65	1.00	0.92	0.77	0.77
18 (457)	1.00	0.80	0.80	0.80	0.73	0.88	0.79	0.74	0.67	0.67	0.67	0.67	1.00	0.73	0.73	0.73	0.73	0.80	0.80	0.80	0.80	0.97	0.82	0.82
20 (508)	0.83	0.83	0.83	0.83	0.81	0.92	0.82	0.76	0.69	0.69	0.69	0.69	0.81	0.81	0.81	0.81	0.81	0.83	0.83	0.83	0.83	1.00	0.87	0.87
22 (559)	0.87	0.87	0.87	0.87	0.89	0.96	0.85	0.79	0.71	0.71	0.71	0.71	0.89	0.89	0.89	0.89	0.89	0.87	0.87	0.87	0.87	0.89	0.89	0.89
24 (610)	0.90	0.90	0.90	0.90	0.97	1.00	0.88	0.82	0.72	0.72	0.72	0.72	0.97	0.97	0.97	0.97	0.97	0.90	0.90	0.90	0.90	0.97	0.97	0.97
30 (762)	1.00	1.00	1.00	1.00	1.00	1.00	0.98	0.89	0.78	0.78	0.78	0.78	1.00	1.00	1.00	1.00	1.00	1.00	1.00	1.00	1.00	1.00	1.00	1.00
36 (914)	1.00	1.00	1.00	1.00	1.00	1.00	1.00	0.97	0.84	0.84	0.84	0.84	1.00	1.00	1.00	1.00	1.00	1.00	1.00	1.00	1.00	1.00	1.00	1.00
>48 (1219)	1.00	1.00	1.00	1.00	1.00	1.00	1.00	1.00	0.95	0.95	0.95	0.95	1.00	1.00	1.00	1.00	1.00	1.00	1.00	1.00	1.00	1.00	1.00	1.00

Table 29 — Load adjustment factors for 1/2-in. diameter fractional threaded rods in cracked concrete ^{1,2,3}

Embedment h_{ef} in (mm)	Spacing Factor in Tension f_{AN}				Edge Distance Factor in Tension f_{RN}				Spacing Factor in Shear ⁴ f_{AV}				Edge Distance in Shear								Conc. Thickness Factor in Shear ⁵ f_{HV}			
	Toward Edge f_{RV}		To Edge f_{RV}		Toward Edge f_{RV}		To Edge f_{RV}		Toward Edge f_{RV}		To Edge f_{RV}		Toward Edge f_{RV}		To Edge f_{RV}		Toward Edge f_{RV}		To Edge f_{RV}					
	2-3/4 (70)	4-1/2 (114)	6 (152)	10 (254)	2-3/4 (70)	4-1/2 (114)	6 (152)	10 (254)	2-3/4 (70)	4-1/2 (114)	6 (152)	10 (254)	2-3/4 (70)	4-1/2 (114)	6 (152)	10 (254)	2-3/4 (70)	4-1/2 (114)	6 (152)	10 (254)	2-3/4 (70)	4-1/2 (114)	6 (152)	10 (254)
1-3/4 (44)	n/a	n/a	n/a	n/a	0.52	0.49	0.45	0.41	n/a	n/a	n/a	n/a	0.16	0.10	0.08	0.05	0.32	0.21	0.16	0.09	n/a	n/a	n/a	n/a
2-1/2 (64)	0.61	0.59	0.57	0.54	0.60	0.56	0.50	0.44	0.57	0.55	0.54	0.53	0.27	0.18	0.13	0.08	0.54	0.35	0.27	0.16	n/a	n/a	n/a	n/a
3 (76)	0.63	0.61	0.58	0.55	0.66	0.60	0.53	0.46	0.58	0.56	0.55	0.54	0.35	0.23	0.17	0.10	0.66	0.47	0.35	0.21	n/a	n/a	n/a	n/a
4 (102)	0.68	0.65	0.61	0.57	0.79	0.70	0.60	0.49	0.61	0.58	0.57	0.55	0.54	0.36	0.27	0.16	0.79	0.70	0.54	0.32	0.67	n/a	n/a	n/a
5 (127)	0.72	0.69	0.64	0.58	0.92	0.80	0.67	0.53	0.64	0.61	0.59	0.56	0.76	0.50	0.38	0.23	0.92	0.80	0.67	0.45	0.75	n/a	n/a	n/a
5-3/4 (146)	0.76	0.71	0.66	0.60	1.00	0.88	0.73	0.56	0.66	0.62	0.60	0.57	0.94	0.62	0.46	0.28	1.00	0.88	0.73	0.56	0.80	0.70	n/a	n/a
6 (152)	0.77	0.72	0.67	0.60	0.91	0.75	0.57	0.67	0.63	0.60	0.57	0.57	1.00	0.66	0.49	0.30	0.91	0.75	0.57	0.57	0.82	0.71	n/a	n/a
7 (178)	0.81	0.76	0.69	0.62	1.00	0.83	0.62	0.69	0.65	0.62	0.59	0.59	0.83	0.62	0.37	0.37	1.00	0.83	0.62	0.62	0.88	0.77	n/a	n/a
7-1/4 (184)	0.82	0.77	0.70	0.62	0.85	0.63	0.70	0.65	0.63	0.59	0.59	0.59	0.87	0.66	0.39	0.39	0.85	0.63	0.63	0.63	0.90	0.78	0.71	n/a
8 (203)	0.86	0.80	0.72	0.63	0.91	0.66	0.72	0.67	0.64	0.60	0.60	0.60	1.00	0.76	0.46	0.46	0.91	0.66	0.66	0.66	0.94	0.82	0.75	n/a
9 (229)	0.90	0.83	0.75	0.65	1.00	0.70	0.75	0.69	0.66	0.61	0.61	0.61	0.91	0.54	0.54	0.54	1.00	0.70	0.70	0.70	1.00	0.87	0.79	n/a
10 (254)	0.95	0.87	0.78	0.67	0.75	0.78	0.71	0.67	0.62	0.62	0.62	0.62	1.00	0.64	0.64	0.64	0.75	0.78	0.71	0.62	0.75	0.92	0.83	n/a
11-1/4 (286)	1.00	0.92	0.81	0.69	0.81	0.81	0.74	0.70	0.64	0.64	0.64	0.64	0.76	0.76	0.76	0.76	0.81	0.81	0.81	0.81	0.97	0.88	0.75	0.75
12 (305)	0.94	0.83	0.70	0.70	0.85	0.83	0.75	0.71	0.65	0.65	0.65	0.65	0.84	0.84	0.84	0.84	0.85	0.85	0.85	0.85	1.00	0.91	0.77	0.77
14 (356)	1.00	0.89	0.73	0.73	0.95	0.89	0.79	0.74	0.67	0.67	0.67	0.67	1.00	0.73	0.73	0.73	0.95	0.89	0.79	0.73	1.00	0.99	0.83	0.83
16 (406)	0.94	0.77	0.77	0.77	1.00	0.94	0.84	0.78	0.70	0.70	0.70	0.70	1.00	0.77	0.77	0.77	1.00	0.94	0.84	0.78	1.00	1.00	0.89	0.89
18 (457)	1.00	0.80	0.80	0.80	1.00	0.88	0.81	0.72	0.67	0.67	0.67	0.67	1.00	0.80	0.80	0.80	1.00	0.88	0.81	0.72	1.00	0.99	0.89	0.89
20 (508)	0.83	0.83	0.83	0.83	0.92	0.85	0.75	0.69	0.69	0.69	0.69	0.69	0.92	0.85	0.85	0.85	0.92	0.83	0.83	0.83	0.92	0.99	0.89	0.89
22 (559)	0.87	0.87	0.87	0.87	0.96	0.88	0.77	0.71	0.71	0.71	0.71	0.71	0.96	0.88	0.88	0.88	0.96	0.88	0.88	0.88	0.96	1.00	0.89	0.89
24 (610)	0.90	0.90	0.90	0.90	1.00	0.92	0.80	0.72	0.67	0.67	0.67	0.67	1.00	0.80	0.80	0.80	1.00	0.92	0.80	0.72	1.00	1.00	0.89	0.89
30 (762)	1.00	1.00	1.00	1.00	1.00	1.00	0.98	0.89	0.78	0.78	0.78	0.78	1.00	0.87	0.87	0.87	1.00	1.00	1.00	1.00	1.00	1.00	1.00	1.00
36 (914)	1.00	1.00	1.00	1.00	1.00	1.00	0.97	0.84	0.84	0.84	0.84	0.84	1.00	0.87	0.87	0.87	1.00	1.00	1.00	1.00	1.00	1.00	1.00	1.00
>48 (1219)	1.00	1.00	1.00	1.00	1.00	1.00	0.95	0.84	0.84	0.84	0.84	0.84	1.00	0.94	0.94	0.94	1.00	1.00	1.00	1.00	1.00	1.00	1.00	1.00

Footnotes for Tables 28 and 29

- Linear interpolation not permitted
- Shaded area with reduced edge distance is permitted provided the installation torque is reduced to 0.30 T_{max} for 5d < s < 16-in. and to 0.5 T_{max} for s > 16-in.
- When

Table 30 — Load adjustment factors for 5/8-in. diameter fractional threaded rods in uncracked concrete ^{1,2,3}

5/8 in Uncracked Concrete	Spacing Factor in Tension f_{AN}				Edge Distance Factor in Tension f_{RN}				Spacing Factor in Shear ⁴ f_{AV}				Edge Distance in Shear								Conc. Thickness Factor in Shear ⁵ f_{HV}				
													⊥ Toward Edge f_{RV}				∥ To Edge f_{RV}								
	Embedment h_{ef} in (mm)	3-1/8 (79)	5-5/8 (143)	7-1/2 (191)	12-1/2 (318)	3-1/8 (79)	5-5/8 (143)	7-1/2 (191)	12-1/2 (318)	3-1/8 (79)	5-5/8 (143)	7-1/2 (191)	12-1/2 (318)	3-1/8 (79)	5-5/8 (143)	7-1/2 (191)	12-1/2 (318)	3-1/8 (79)	5-5/8 (143)	7-1/2 (191)	12-1/2 (318)	3-1/8 (79)	5-5/8 (143)	7-1/2 (191)	12-1/2 (318)
1-3/4 (44)	n/a	n/a	n/a	n/a	0.39	0.25	0.19	0.11	n/a	n/a	n/a	n/a	0.09	0.05	0.04	0.02	0.19	0.10	0.08	0.05	n/a	n/a	n/a	n/a	
3-1/8 (79)	0.61	0.59	0.57	0.54	0.52	0.32	0.23	0.14	0.56	0.54	0.53	0.52	0.22	0.12	0.09	0.05	0.45	0.24	0.18	0.11	n/a	n/a	n/a	n/a	
4 (102)	0.65	0.62	0.59	0.55	0.61	0.36	0.27	0.16	0.58	0.55	0.54	0.53	0.32	0.18	0.13	0.08	0.61	0.35	0.26	0.16	n/a	n/a	n/a	n/a	
4-5/8 (117)	0.67	0.64	0.60	0.56	0.68	0.40	0.29	0.17	0.59	0.56	0.55	0.54	0.40	0.22	0.16	0.10	0.68	0.40	0.29	0.17	0.60	n/a	n/a	n/a	
5 (127)	0.68	0.65	0.61	0.57	0.74	0.42	0.31	0.18	0.60	0.57	0.55	0.54	0.45	0.25	0.19	0.11	0.74	0.42	0.31	0.18	0.63	n/a	n/a	n/a	
6 (152)	0.72	0.68	0.63	0.58	0.89	0.47	0.35	0.20	0.62	0.58	0.56	0.55	0.59	0.32	0.24	0.15	0.89	0.47	0.35	0.20	0.69	n/a	n/a	n/a	
7 (178)	0.76	0.71	0.66	0.59	1.00	0.53	0.39	0.23	0.64	0.59	0.58	0.55	0.75	0.41	0.31	0.18	1.00	0.53	0.39	0.23	0.74	n/a	n/a	n/a	
7-1/8 (181)	0.76	0.71	0.66	0.60		0.54	0.40	0.23	0.64	0.59	0.58	0.55	0.77	0.42	0.31	0.19		0.54	0.40	0.23	0.75	0.61	n/a	n/a	
8 (203)	0.79	0.74	0.68	0.61		0.61	0.45	0.26	0.66	0.60	0.59	0.56	0.91	0.50	0.37	0.22		0.61	0.45	0.26	0.79	0.65	n/a	n/a	
9 (229)	0.83	0.77	0.70	0.62		0.69	0.51	0.30	0.68	0.62	0.60	0.57	1.00	0.60	0.45	0.27		0.69	0.51	0.30	0.84	0.69	0.62	n/a	
10 (254)	0.87	0.80	0.72	0.63		0.76	0.56	0.33	0.70	0.63	0.61	0.58		0.70	0.52	0.31		0.76	0.56	0.33	0.89	0.72	0.66	n/a	
11 (279)	0.90	0.83	0.74	0.65		0.84	0.62	0.36	0.72	0.64	0.62	0.58		0.81	0.60	0.36		0.84	0.62	0.36	0.93	0.76	0.69	n/a	
12 (305)	0.94	0.86	0.77	0.66		0.92	0.67	0.39	0.74	0.66	0.63	0.59		0.92	0.69	0.41		0.92	0.67	0.39	0.97	0.79	0.72	n/a	
14 (356)	1.00	0.91	0.81	0.69		1.00	0.79	0.46	0.77	0.68	0.65	0.61		1.00	0.87	0.52		1.00	0.79	0.46	1.00	0.86	0.78	0.66	
16 (406)		0.97	0.86	0.71			0.90	0.53	0.81	0.71	0.67	0.62			1.00	0.64			0.90	0.53		0.92	0.83	0.70	
18 (457)		1.00	0.90	0.74			1.00	0.59	0.85	0.74	0.69	0.64				0.76			1.00	0.59		0.97	0.88	0.74	
20 (508)			0.94	0.77				0.66	0.89	0.76	0.72	0.65				0.89				0.66		1.00	0.93	0.78	
22 (559)				0.99				0.72	0.93	0.79	0.74	0.67								0.72				0.98	0.82
24 (610)				1.00				0.79	0.97	0.81	0.76	0.68								0.79				1.00	0.86
26 (660)					0.85			0.85	1.00	0.84	0.78	0.70								0.85					0.90
28 (711)					0.87			0.92		0.87	0.80	0.72								0.92					0.93
30 (762)					0.90			0.99		0.89	0.82	0.73								0.99					0.96
36 (914)					0.98			1.00		0.97	0.89	0.78								1.00					1.00
>48 (1219)					1.00					1.00	1.00	0.87													

Table 31 — Load adjustment factors for 5/8-in. diameter fractional threaded rods in cracked concrete ^{1,2,3}

5/8 in Cracked Concrete	Spacing Factor in Tension f_{AN}				Edge Distance Factor in Tension f_{RN}				Spacing Factor in Shear ⁴ f_{AV}				Edge Distance in Shear								Conc. Thickness Factor in Shear ⁵ f_{HV}			
													⊥ Toward Edge f_{RV}				∥ To Edge f_{RV}							
	Embedment h_{ef} in (mm)	3-1/8 (79)	5-5/8 (143)	7-1/2 (191)	12-1/2 (318)	3-1/8 (79)	5-5/8 (143)	7-1/2 (191)	12-1/2 (318)	3-1/8 (79)	5-5/8 (143)	7-1/2 (191)	12-1/2 (318)	3-1/8 (79)	5-5/8 (143)	7-1/2 (191)	12-1/2 (318)	3-1/8 (79)	5-5/8 (143)	7-1/2 (191)	12-1/2 (318)	3-1/8 (79)	5-5/8 (143)	7-1/2 (191)
1-3/4 (44)	n/a	n/a	n/a	n/a	0.49	0.46	0.43	0.40	n/a	n/a	n/a	n/a	0.12	0.07	0.06	0.03	0.24	0.15	0.11	0.07	n/a	n/a	n/a	n/a
3-1/8 (79)	0.61	0.59	0.57	0.54	0.61	0.56	0.50	0.44	0.57	0.55	0.54	0.53	0.29	0.18	0.13	0.08	0.58	0.35	0.27	0.16	n/a	n/a	n/a	n/a
4 (102)	0.65	0.62	0.59	0.55	0.69	0.62	0.55	0.46	0.59	0.57	0.56	0.54	0.42	0.26	0.19	0.12	0.69	0.51	0.38	0.23	n/a	n/a	n/a	n/a
4-5/8 (117)	0.67	0.64	0.60	0.56	0.76	0.67	0.58	0.48	0.61	0.58	0.56	0.55	0.52	0.32	0.24	0.14	0.76	0.64	0.48	0.29	0.66	n/a	n/a	n/a
5 (127)	0.68	0.65	0.61	0.57	0.80	0.70	0.60	0.49	0.62	0.58	0.57	0.55	0.59	0.36	0.27	0.16	0.80	0.70	0.54	0.32	0.68	n/a	n/a	n/a
6 (152)	0.72	0.68	0.63	0.58	0.91	0.78	0.66	0.53	0.64	0.60	0.58	0.56	0.77	0.47	0.35	0.21	0.91	0.78	0.66	0.42	0.75	n/a	n/a	n/a
7 (178)	0.76	0.71	0.66	0.59	1.00	0.87	0.72	0.56	0.66	0.62	0.60	0.57	0.97	0.59	0.45	0.27	1.00	0.87	0.72	0.53	0.81	n/a	n/a	n/a
7-1/8 (181)	0.76	0.71	0.66	0.60		0.88	0.73	0.56	0.67	0.62	0.60	0.57	1.00	0.61	0.46	0.27		0.88	0.73	0.55	0.82	0.69	n/a	n/a
8 (203)	0.79	0.74	0.68	0.61		0.96	0.78	0.59	0.69	0.63	0.61	0.58		0.73	0.54	0.33		0.96	0.78	0.59	0.87	0.73	n/a	n/a
9 (229)	0.83	0.77	0.70	0.62		1.00	0.85	0.62	0.71	0.65	0.62	0.59		0.87	0.65	0.39		1.00	0.85	0.62	0.92	0.78	0.71	n/a
10 (254)	0.87	0.80	0.72	0.63			0.91	0.66	0.73	0.67	0.64	0.60		1.00	0.76	0.46			0.91	0.66	0.97	0.82	0.75	n/a
11 (279)	0.90	0.83	0.74	0.65			0.98	0.69	0.76	0.69	0.65	0.61			0.88	0.53			0.98	0.69	1.00	0.86	0.78	n/a
12 (305)	0.94	0.86	0.77	0.66			1.00	0.73	0.78	0.70	0.67	0.62			1.00	0.60			1.00	0.73		0.90	0.82	n/a
14 (356)	1.00	0.91	0.81	0.69				0.81	0.83	0.74	0.69	0.64				0.76				0.81		0.97	0.88	0.74
16 (406)		0.97	0.86	0.71				0.89	0.87	0.77	0.72	0.66				0.92				0.89		1.00	0.94	0.80
18 (457)		1.00	0.90	0.74				0.97	0.92	0.80	0.75	0.68				1.00				0.97			1.00	0.84
20 (508)			0.94	0.77				1.00	0.97	0.84	0.78	0.70								1.00				0.89
22 (559)				0.99					1.00	0.87	0.81	0.72												0.93
24 (610)				1.00						0.90	0.83	0.74												0.97
26 (660)					0.85					0.94	0.86	0.76												1.00
28 (711)					0.87					0.97	0.89	0.78												
30 (762)					0.90					1.00	0.92	0.80												
36 (914)					0.98						1.00	0.86												
>48 (1219)					1.00							0.97												

Footnotes for Tables 30 and 31

- Linear interpolation not permitted
- Shaded area with reduced edge distance is permitted provided the installation torque is reduced to 0.30 T_{max} for 5d < s < 16-in. and to 0.5 T_{max} for s > 16-in.
- When combining multiple load adjustment factors (e.g. for a four-anchor pattern in a corner with thin concrete member) the design can become very conservative. To optimize the design, use Hilti PROFIS Anchor Design software or perform anchor calculation using design equations from ACI 318-14 Chapter 17 and CSA A23.3-14 Annex D.
- Spacing factor reduction in shear, f_{AV} , assumes an influence of a nearby edge. If no edge exists, then $f_{AV} = f_{AN}$.
- Concrete thickness reduction factor in shear, f_{HV} , assumes an influence of a nearby edge. If no edge exists, then $f_{HV} = 1.0$.

Table 32 — Load adjustment factors for 3/4-in. diameter fractional threaded rods in uncracked concrete^{1,2,3}

3/4 in Uncracked Concrete	Spacing Factor in Tension f_{AN}				Edge Distance Factor in Tension f_{RN}				Spacing Factor in Shear ⁴ f_{AV}				Edge Distance in Shear								Conc. Thickness Factor in Shear ⁵ f_{HV}			
													⊥ Toward Edge f_{RV}				∥ To Edge f_{RV}							
Embedment h_{ef} in (mm)	3-1/2 (89)	6-3/4 (171)	9 (229)	15 (381)	3-1/2 (89)	6-3/4 (171)	9 (229)	15 (381)	3-1/2 (89)	6-3/4 (171)	9 (229)	15 (381)	3-1/2 (89)	6-3/4 (171)	9 (229)	15 (381)	3-1/2 (89)	6-3/4 (171)	9 (229)	15 (381)	3-1/2 (89)	6-3/4 (171)	9 (229)	15 (381)
1-3/4 (44)	n/a	n/a	n/a	n/a	0.38	0.24	0.18	0.10	n/a	n/a	n/a	n/a	0.09	0.04	0.03	0.02	0.17	0.08	0.06	0.04	n/a	n/a	n/a	n/a
3-3/4 (95)	0.62	0.59	0.57	0.54	0.55	0.32	0.23	0.14	0.57	0.54	0.53	0.52	0.27	0.12	0.09	0.06	0.53	0.25	0.19	0.11	n/a	n/a	n/a	n/a
4 (102)	0.62	0.60	0.57	0.54	0.58	0.33	0.24	0.14	0.57	0.54	0.54	0.53	0.29	0.14	0.10	0.06	0.58	0.27	0.20	0.12	n/a	n/a	n/a	n/a
5 (127)	0.66	0.62	0.59	0.56	0.68	0.37	0.27	0.16	0.59	0.56	0.55	0.53	0.41	0.19	0.14	0.09	0.68	0.37	0.27	0.16	n/a	n/a	n/a	n/a
5-1/4 (133)	0.66	0.63	0.60	0.56	0.71	0.38	0.28	0.17	0.60	0.56	0.55	0.53	0.44	0.20	0.15	0.09	0.71	0.38	0.28	0.17	0.62	n/a	n/a	n/a
6 (152)	0.69	0.65	0.61	0.57	0.81	0.42	0.31	0.18	0.61	0.57	0.55	0.54	0.54	0.25	0.19	0.11	0.81	0.42	0.31	0.18	0.66	n/a	n/a	n/a
7 (178)	0.72	0.67	0.63	0.58	0.90	0.47	0.34	0.20	0.63	0.58	0.56	0.55	0.68	0.32	0.24	0.14	0.90	0.47	0.34	0.20	0.72	n/a	n/a	n/a
8 (203)	0.75	0.70	0.65	0.59	0.99	0.52	0.38	0.22	0.65	0.59	0.57	0.55	0.83	0.39	0.29	0.17	0.99	0.52	0.38	0.22	0.77	n/a	n/a	n/a
8-1/2 (216)	0.76	0.71	0.66	0.59	1.00	0.55	0.40	0.24	0.66	0.59	0.58	0.56	0.91	0.42	0.32	0.19	1.00	0.55	0.40	0.24	0.79	0.61	n/a	n/a
9 (229)	0.78	0.72	0.67	0.60		0.58	0.43	0.25	0.67	0.60	0.58	0.56	0.99	0.46	0.34	0.21		0.58	0.43	0.25	0.81	0.63	n/a	n/a
10 (254)	0.81	0.75	0.69	0.61		0.64	0.47	0.28	0.68	0.61	0.59	0.56	1.00	0.54	0.40	0.24		0.64	0.47	0.28	0.86	0.66	n/a	n/a
10-3/4 (273)	0.83	0.77	0.70	0.62		0.69	0.51	0.30	0.70	0.62	0.60	0.57		0.60	0.45	0.27		0.69	0.51	0.30	0.89	0.69	0.63	n/a
12 (305)	0.87	0.80	0.72	0.63		0.77	0.57	0.33	0.72	0.63	0.61	0.58		0.71	0.53	0.32		0.77	0.57	0.33	0.94	0.73	0.66	n/a
14 (356)	0.93	0.85	0.76	0.66		0.90	0.66	0.39	0.76	0.65	0.63	0.59		0.89	0.67	0.40		0.90	0.66	0.39	1.00	0.79	0.71	n/a
16 (406)	1.00	0.90	0.80	0.68		1.00	0.76	0.44	0.79	0.68	0.65	0.60		1.00	0.82	0.49		1.00	0.76	0.44		0.84	0.76	n/a
16-3/4 (425)		0.91	0.81	0.69			0.79	0.46	0.81	0.68	0.65	0.61			0.87	0.52			0.79	0.46		0.86	0.78	0.66
18 (457)		0.94	0.83	0.70			0.85	0.50	0.83	0.70	0.66	0.62			0.97	0.58			0.85	0.50		0.89	0.81	0.68
20 (508)		0.99	0.87	0.72			0.95	0.55	0.87	0.72	0.68	0.63			1.00	0.68			0.95	0.55		0.94	0.85	0.72
22 (559)		1.00	0.91	0.74			1.00	0.61	0.91	0.74	0.70	0.64				0.79			1.00	0.61		0.99	0.89	0.75
24 (610)			0.94	0.77				0.67	0.94	0.76	0.72	0.66				0.90				0.67		1.00	0.93	0.79
26 (660)			0.98	0.79				0.72	0.98	0.79	0.74	0.67				1.00				0.72			0.97	0.82
28 (711)			1.00	0.81				0.78	1.00	0.81	0.75	0.68								0.78			1.00	0.85
30 (762)				0.83				0.83		0.83	0.77	0.69												0.88
36 (914)				0.90				1.00		0.90	0.83	0.73												0.97
>48 (1219)				1.00						1.00	0.94	0.81												1.00

Table 33 — Load adjustment factors for 3/4-in. diameter fractional threaded rods in cracked concrete^{1,2,3}

3/4 in Cracked Concrete	Spacing Factor in Tension f_{AN}				Edge Distance Factor in Tension f_{RN}				Spacing Factor in Shear ⁴ f_{AV}				Edge Distance in Shear								Conc. Thickness Factor in Shear ⁵ f_{HV}			
													⊥ Toward Edge f_{RV}				∥ To Edge f_{RV}							
Embedment h_{ef} in (mm)	3-1/2 (89)	6-3/4 (171)	9 (229)	15 (381)	3-1/2 (89)	6-3/4 (171)	9 (229)	15 (381)	3-1/2 (89)	6-3/4 (171)	9 (229)	15 (381)	3-1/2 (89)	6-3/4 (171)	9 (229)	15 (381)	3-1/2 (89)	6-3/4 (171)	9 (229)	15 (381)	3-1/2 (89)	6-3/4 (171)	9 (229)	15 (381)
1-3/4 (44)	n/a	n/a	n/a	n/a	0.47	0.44	0.42	0.39	n/a	n/a	n/a	n/a	0.10	0.06	0.04	0.03	0.21	0.12	0.09	0.05	n/a	n/a	n/a	n/a
3-3/4 (95)	0.62	0.59	0.57	0.54	0.62	0.56	0.50	0.44	0.58	0.55	0.54	0.53	0.32	0.18	0.14	0.08	0.62	0.37	0.28	0.17	n/a	n/a	n/a	n/a
4 (102)	0.62	0.60	0.57	0.54	0.64	0.57	0.51	0.44	0.58	0.56	0.55	0.53	0.36	0.20	0.15	0.09	0.64	0.40	0.30	0.18	n/a	n/a	n/a	n/a
5 (127)	0.66	0.62	0.59	0.56	0.72	0.63	0.56	0.47	0.60	0.57	0.56	0.54	0.50	0.28	0.21	0.13	0.72	0.56	0.42	0.25	n/a	n/a	n/a	n/a
5-1/4 (133)	0.66	0.63	0.60	0.56	0.74	0.65	0.57	0.47	0.61	0.58	0.56	0.54	0.54	0.30	0.23	0.14	0.74	0.61	0.46	0.27	0.66	n/a	n/a	n/a
6 (152)	0.69	0.65	0.61	0.57	0.81	0.70	0.60	0.49	0.63	0.59	0.57	0.55	0.66	0.37	0.28	0.17	0.81	0.70	0.56	0.33	0.71	n/a	n/a	n/a
7 (178)	0.72	0.67	0.63	0.58	0.90	0.77	0.65	0.52	0.65	0.60	0.58	0.56	0.83	0.47	0.35	0.21	0.90	0.77	0.65	0.42	0.77	n/a	n/a	n/a
8 (203)	0.75	0.70	0.65	0.59	0.99	0.84	0.70	0.55	0.67	0.61	0.59	0.57	1.00	0.57	0.43	0.26	0.99	0.84	0.70	0.51	0.82	n/a	n/a	n/a
8-1/2 (216)	0.76	0.71	0.66	0.59	1.00	0.88	0.72	0.56	0.68	0.62	0.60	0.57		0.63	0.47	0.28	1.00	0.88	0.72	0.56	0.84	0.70	n/a	n/a
9 (229)	0.78	0.72	0.67	0.60		0.91	0.75	0.57	0.69	0.63	0.61	0.58		0.68	0.51	0.31		0.91	0.75	0.57	0.87	0.72	n/a	n/a
10 (254)	0.81	0.75	0.69	0.61		0.99	0.80	0.60	0.71	0.64	0.62	0.58		0.80	0.60	0.36		0.99	0.80	0.60	0.92	0.76	n/a	n/a
10-3/4 (273)	0.83	0.77	0.70	0.62		1.00	0.84	0.62	0.73	0.65	0.63	0.59		0.89	0.67	0.40		1.00	0.84	0.62	0.95	0.79	0.71	n/a
12 (305)	0.87	0.80	0.72	0.63			0.91	0.66	0.75	0.67	0.64	0.60		1.00	0.79	0.47			0.91	0.66	1.00	0.83	0.75	n/a
14 (356)	0.93	0.85	0.76	0.66			1.00	0.72	0.79	0.70	0.67	0.62			0.99	0.60			1.00	0.72		0.90	0.81	n/a
16 (406)	1.00	0.90	0.80	0.68				0.78	0.84	0.73	0.69	0.63			1.00	0.73				0.78		0.96	0.87	n/a
16-3/4 (425)		0.91	0.81	0.69				0.81	0.85	0.74	0.70	0.64				0.78				0.81		0.98	0.89	0.75
18 (457)		0.94	0.83	0.70				0.85	0.88	0.76	0.71	0.65				0.87				0.85		1.00	0.92	0.78
20 (508)		0.99	0.87	0.72				0.91	0.92	0.79	0.74	0.67				1.00				0.91			0.97	0.82
22 (559)		1.00	0.91	0.74				0.98	0.96	0.82	0.76	0.69								0.98			1.00	0.86
24 (610)			0.94	0.77				1.00	1.00	0.84	0.78	0.70								1.00				0.90
26 (660)			0.98	0.79						0.87	0.81	0.72												0.94
28 (711)			1.00	0.81						0.90	0.83	0.74												0.97
30 (762)				0.83						0.93	0.86	0.75												1.00
36 (914)				0.90						1.00	0.93	0.80												
>48 (1219)				1.00						1.00	0.90	0.90												

Footnotes for Tables 32 and 33

- Linear interpolation not permitted
- Shaded area with reduced edge distance is permitted provided the installation torque is reduced to 0.30 T_{max} for 5d < s < 16-in. and to 0.5 T_{max} for s > 16-in.
- When combining multiple load adjustment factors (e.g. for a four-anchor pattern in a corner with thin concrete member) the design can become very conservative. To optimize the design, use Hilti PROFIS Anchor Design software or perform anchor calculation using design equations from ACI 318-14 Chapter 17 and CSA A23.3-14 Annex D.
- Spacing factor reduction in shear, f_{AV} , assumes an influence of a nearby edge. If no edge exists, then $f_{AV} = f_{AN}$.
- Concrete thickness reduction factor in shear, f_{HV} , assumes an influence of a nearby edge. If no edge exists, then $f_{HV} = 1.0$.

Table 34 – Load adjustment factors for 7/8-in. diameter fractional threaded rods in uncracked concrete ^{1,2,3}

7/8 in Uncracked Concrete	Spacing Factor in Tension f_{AN}				Edge Distance Factor in Tension f_{RN}				Spacing Factor in Shear ⁴ f_{AV}				Edge Distance in Shear								Conc. Thickness Factor in Shear ⁵ f_{HV}			
	Toward Edge f_{RV}		To Edge f_{RV}		Toward Edge f_{RV}		To Edge f_{RV}		Toward Edge f_{RV}		To Edge f_{RV}		Toward Edge f_{RV}		To Edge f_{RV}		Toward Edge f_{RV}		To Edge f_{RV}		Toward Edge f_{RV}		To Edge f_{RV}	
Embedment h_{ef} in (mm)	3-1/2 (89)	7-7/8 (200)	10-1/2 (267)	17-1/2 (445)	3-1/2 (89)	7-7/8 (200)	10-1/2 (267)	17-1/2 (445)	3-1/2 (89)	7-7/8 (200)	10-1/2 (267)	17-1/2 (445)	3-1/2 (89)	7-7/8 (200)	10-1/2 (267)	17-1/2 (445)	3-1/2 (89)	7-7/8 (200)	10-1/2 (267)	17-1/2 (445)	3-1/2 (89)	7-7/8 (200)	10-1/2 (267)	17-1/2 (445)
1-3/4 (44)	n/a	n/a	n/a	n/a	0.39	0.23	0.17	0.10	n/a	n/a	n/a	n/a	0.09	0.03	0.02	0.01	0.18	0.06	0.04	0.03	n/a	n/a	n/a	n/a
4-3/8 (111)	0.62	0.59	0.57	0.54	0.62	0.32	0.24	0.14	0.58	0.54	0.53	0.52	0.35	0.12	0.09	0.05	0.62	0.24	0.18	0.11	n/a	n/a	n/a	n/a
5 (127)	0.64	0.61	0.58	0.55	0.66	0.34	0.25	0.15	0.59	0.55	0.54	0.53	0.43	0.14	0.11	0.07	0.66	0.29	0.22	0.13	n/a	n/a	n/a	n/a
5-1/2 (140)	0.65	0.62	0.59	0.55	0.70	0.36	0.27	0.16	0.60	0.55	0.54	0.53	0.50	0.17	0.13	0.08	0.70	0.33	0.25	0.15	0.65	n/a	n/a	n/a
6 (152)	0.66	0.63	0.60	0.56	0.74	0.38	0.28	0.16	0.61	0.56	0.55	0.53	0.57	0.19	0.14	0.09	0.74	0.38	0.28	0.16	0.68	n/a	n/a	n/a
7 (178)	0.69	0.65	0.61	0.57	0.81	0.42	0.31	0.18	0.63	0.56	0.55	0.54	0.71	0.24	0.18	0.11	0.81	0.42	0.31	0.18	0.73	n/a	n/a	n/a
8 (203)	0.72	0.67	0.63	0.58	0.90	0.46	0.34	0.20	0.65	0.57	0.56	0.54	0.87	0.29	0.22	0.13	0.90	0.46	0.34	0.20	0.78	n/a	n/a	n/a
9 (229)	0.74	0.69	0.64	0.59	0.98	0.51	0.37	0.22	0.67	0.58	0.57	0.55	1.00	0.35	0.26	0.16	0.98	0.51	0.37	0.22	0.83	n/a	n/a	n/a
9-7/8 (251)	0.77	0.71	0.66	0.59	1.00	0.55	0.41	0.24	0.69	0.59	0.57	0.55		0.40	0.30	0.18	1.00	0.55	0.41	0.24	0.87	0.60	n/a	n/a
10 (254)	0.77	0.71	0.66	0.60		0.56	0.41	0.24	0.69	0.59	0.58	0.55		0.41	0.31	0.18		0.56	0.41	0.24	0.87	0.61	n/a	n/a
11 (279)	0.80	0.73	0.67	0.60		0.61	0.45	0.26	0.71	0.60	0.58	0.56		0.47	0.35	0.21		0.61	0.45	0.26	0.91	0.64	n/a	n/a
12 (305)	0.82	0.75	0.69	0.61		0.67	0.49	0.29	0.73	0.61	0.59	0.56		0.54	0.40	0.24		0.67	0.49	0.29	0.95	0.66	n/a	n/a
12-1/2 (318)	0.84	0.76	0.70	0.62		0.70	0.51	0.30	0.74	0.61	0.59	0.57		0.57	0.43	0.26		0.70	0.51	0.30	0.97	0.68	0.62	n/a
14 (356)	0.88	0.80	0.72	0.63		0.78	0.58	0.34	0.77	0.63	0.61	0.58		0.68	0.51	0.31		0.78	0.58	0.34	1.00	0.72	0.65	n/a
16 (406)	0.93	0.84	0.75	0.65		0.89	0.66	0.39	0.80	0.65	0.62	0.59		0.83	0.62	0.37		0.89	0.66	0.39		0.77	0.70	n/a
18 (457)	0.99	0.88	0.79	0.67		1.00	0.74	0.43	0.84	0.67	0.64	0.60		0.99	0.74	0.44		1.00	0.74	0.43		0.81	0.74	n/a
19-1/2 (495)	1.00	0.91	0.81	0.69			0.80	0.47	0.87	0.68	0.65	0.61		1.00	0.84	0.50			0.80	0.47		0.85	0.77	0.65
20 (508)		0.92	0.82	0.69			0.82	0.48	0.88	0.68	0.65	0.61			0.87	0.52			0.82	0.48		0.86	0.78	0.66
22 (559)		0.97	0.85	0.71			0.90	0.53	0.92	0.70	0.67	0.62			1.00	0.60			0.90	0.53		0.90	0.82	0.69
24 (610)		1.00	0.88	0.73			0.99	0.58	0.96	0.72	0.68	0.63				0.68			0.99	0.58		0.94	0.85	0.72
26 (660)			0.91	0.75			1.00	0.63	0.99	0.74	0.70	0.64				0.77			1.00	0.63		0.98	0.89	0.75
28 (711)			0.94	0.77				0.67	1.00	0.76	0.71	0.65				0.86				0.67		1.00	0.92	0.78
30 (762)			0.98	0.79				0.72		0.78	0.73	0.66				0.96				0.72			0.95	0.80
36 (914)			1.00	0.84				0.87		0.83	0.77	0.69				1.00				0.87			1.00	0.88
>48 (1219)				0.96				1.00		0.94	0.86	0.76								1.00				1.00

Table 35 – Load adjustment factors for 7/8-in. diameter fractional threaded rods in cracked concrete ^{1,2,3}

7/8 in Cracked Concrete	Spacing Factor in Tension f_{AN}				Edge Distance Factor in Tension f_{RN}				Spacing Factor in Shear ⁴ f_{AV}				Edge Distance in Shear								Conc. Thickness Factor in Shear ⁵ f_{HV}			
	Toward Edge f_{RV}		To Edge f_{RV}		Toward Edge f_{RV}		To Edge f_{RV}		Toward Edge f_{RV}		To Edge f_{RV}		Toward Edge f_{RV}		To Edge f_{RV}		Toward Edge f_{RV}		To Edge f_{RV}		Toward Edge f_{RV}		To Edge f_{RV}	
Embedment h_{ef} in (mm)	3-1/2 (89)	7-7/8 (200)	10-1/2 (267)	17-1/2 (445)	3-1/2 (89)	7-7/8 (200)	10-1/2 (267)	17-1/2 (445)	3-1/2 (89)	7-7/8 (200)	10-1/2 (267)	17-1/2 (445)	3-1/2 (89)	7-7/8 (200)	10-1/2 (267)	17-1/2 (445)	3-1/2 (89)	7-7/8 (200)	10-1/2 (267)	17-1/2 (445)	3-1/2 (89)	7-7/8 (200)	10-1/2 (267)	17-1/2 (445)
1-3/4 (44)	n/a	n/a	n/a	n/a	0.45	0.43	0.41	0.38	n/a	n/a	n/a	n/a	0.10	0.05	0.03	0.02	0.20	0.09	0.07	0.04	n/a	n/a	n/a	n/a
4-3/8 (111)	0.62	0.59	0.57	0.54	0.62	0.56	0.50	0.44	0.59	0.55	0.54	0.53	0.40	0.18	0.14	0.08	0.62	0.37	0.28	0.17	n/a	n/a	n/a	n/a
5 (127)	0.64	0.61	0.58	0.55	0.66	0.59	0.52	0.45	0.60	0.56	0.55	0.54	0.49	0.23	0.17	0.10	0.66	0.45	0.34	0.20	n/a	n/a	n/a	n/a
5-1/2 (140)	0.65	0.62	0.59	0.55	0.70	0.62	0.54	0.46	0.61	0.57	0.56	0.54	0.56	0.26	0.19	0.12	0.70	0.52	0.39	0.23	0.67	n/a	n/a	n/a
6 (152)	0.66	0.63	0.60	0.56	0.74	0.64	0.56	0.47	0.62	0.57	0.56	0.54	0.64	0.30	0.22	0.13	0.74	0.59	0.44	0.27	0.70	n/a	n/a	n/a
7 (178)	0.69	0.65	0.61	0.57	0.81	0.70	0.60	0.49	0.64	0.59	0.57	0.55	0.81	0.37	0.28	0.17	0.81	0.70	0.56	0.34	0.76	n/a	n/a	n/a
8 (203)	0.72	0.67	0.63	0.58	0.90	0.76	0.64	0.52	0.66	0.60	0.58	0.56	0.98	0.46	0.34	0.21	0.90	0.76	0.64	0.41	0.81	n/a	n/a	n/a
9 (229)	0.74	0.69	0.64	0.59	0.98	0.82	0.68	0.54	0.69	0.61	0.59	0.57	1.00	0.54	0.41	0.24	0.98	0.82	0.68	0.49	0.86	n/a	n/a	n/a
9-7/8 (251)	0.77	0.71	0.66	0.59	1.00	0.87	0.72	0.56	0.70	0.62	0.60	0.57		0.63	0.47	0.28	1.00	0.87	0.72	0.56	0.90	0.70	n/a	n/a
10 (254)	0.77	0.71	0.66	0.60		0.88	0.73	0.56	0.71	0.62	0.60	0.57		0.64	0.48	0.29		0.88	0.73	0.56	0.91	0.70	n/a	n/a
11 (279)	0.80	0.73	0.67	0.60		0.95	0.77	0.59	0.73	0.64	0.61	0.58		0.73	0.55	0.33		0.95	0.77	0.59	0.95	0.74	n/a	n/a
12 (305)	0.82	0.75	0.69	0.61		1.00	0.82	0.61	0.75	0.65	0.62	0.59		0.84	0.63	0.38		1.00	0.82	0.61	0.99	0.77	n/a	n/a
12-1/2 (318)	0.84	0.76	0.70	0.62			0.84	0.62	0.76	0.65	0.63	0.59		0.89	0.67	0.40			0.84	0.62	1.00	0.79	0.71	n/a
14 (356)	0.88	0.80	0.72	0.63			0.91	0.66	0.79	0.67	0.64	0.60		1.00	0.79	0.47			0.91	0.66		0.83	0.76	n/a
16 (406)	0.93	0.84	0.75	0.65			1.00	0.71	0.83	0.70	0.66	0.62			0.97	0.58			1.00	0.71		0.89	0.81	n/a
18 (457)	0.99	0.88	0.79	0.67				0.76	0.87	0.72	0.68	0.63			1.00	0.69				0.76		0.94	0.86	n/a
19-1/2 (495)	1.00	0.91	0.81	0.69				0.80	0.90	0.74	0.70	0.64				0.78				0.80		0.98	0.89	0.75
20 (508)		0.92	0.82	0.69				0.82	0.91	0.75	0.70	0.64				0.81				0.82		0.99	0.90	0.76
22 (559)		0.97	0.85	0.71				0.87	0.95	0.77	0.72	0.66				0.94				0.87		1.00	0.95	0.80
24 (610)		1.00	0.88	0.73				0.93	0.99	0.80	0.74	0.67				1.00				0.93			0.99	0.83
26 (660)			0.91	0.75				0.99	1.00	0.82	0.76	0.69								0.99			1.00	0.87
28 (711)			0.94	0.77				1.00		0.85	0.79	0.70								1.00				0.90
30 (762)			0.98	0.79						0.87	0.81	0.72												0.93
36 (914)			1.00	0.84						0.94	0.87	0.76												1.00
>48 (1219)				0.96						1.00	0.99	0.85												1.00

Footnotes for Tables 34 and 35

- Linear interpolation not permitted
- Shaded area with reduced edge distance is permitted provided the installation torque is reduced to 0.30 T_{max} for 5d < s < 16-in. and to 0.5 T_{max} for s > 16-in.
- When combining multiple load adjustment factors (e.g. for a four-anchor pattern in a corner with thin concrete member) the design can become very conservative. To optimize the design, use Hilti PROFIS Anchor Design software or perform anchor calculation using design equations from ACI 318-14 Chapter 17 and CSA A23.3-14 Annex D.
- Spacing factor reduction in shear, f_{AV} , assumes an influence of a nearby edge. If no edge exists, then $f_{AV} = f_{AN}$.
- Concrete thickness reduction factor in shear, f_{HV} , assumes an influence of a nearby edge. If no edge exists, then $f_{HV} = 1.0$.

Table 36 – Load adjustment factors for 1-in. diameter fractional threaded rods in uncracked concrete^{1,2,3}

1 in Uncracked Concrete	Spacing Factor in Tension f_{AN}				Edge Distance Factor in Tension f_{RN}				Spacing Factor in Shear ⁴ f_{AV}				Edge Distance in Shear								Conc. Thickness Factor in Shear ⁵ f_{HV}			
													⊥ Toward Edge f_{RV}				∥ To Edge f_{RV}							
Embedment h_{ef} in (mm)	4 (102)	9 (229)	12 (305)	20 (508)	4 (102)	9 (229)	12 (305)	20 (508)	4 (102)	9 (229)	12 (305)	20 (508)	4 (102)	9 (229)	12 (305)	20 (508)	4 (102)	9 (229)	12 (305)	20 (508)	4 (102)	9 (229)	12 (305)	20 (508)
1-3/4 (44)	n/a	n/a	n/a	n/a	0.38	0.23	0.17	0.10	n/a	n/a	n/a	n/a	0.08	0.02	0.02	0.01	0.15	0.05	0.04	0.02	n/a	n/a	n/a	n/a
5 (127)	0.62	0.59	0.57	0.54	0.62	0.32	0.24	0.14	0.59	0.54	0.53	0.52	0.37	0.11	0.09	0.05	0.62	0.23	0.17	0.10	n/a	n/a	n/a	n/a
6 (152)	0.64	0.61	0.58	0.55	0.69	0.35	0.26	0.15	0.60	0.55	0.54	0.53	0.48	0.15	0.11	0.07	0.69	0.30	0.22	0.13	n/a	n/a	n/a	n/a
6-1/4 (159)	0.65	0.62	0.59	0.55	0.70	0.36	0.27	0.16	0.61	0.55	0.54	0.53	0.51	0.16	0.12	0.07	0.70	0.32	0.24	0.14	0.65	n/a	n/a	n/a
7 (178)	0.67	0.63	0.60	0.56	0.75	0.39	0.29	0.17	0.62	0.55	0.55	0.53	0.61	0.19	0.14	0.09	0.75	0.38	0.28	0.17	0.69	n/a	n/a	n/a
8 (203)	0.69	0.65	0.61	0.57	0.82	0.42	0.31	0.18	0.64	0.56	0.55	0.54	0.74	0.23	0.17	0.10	0.82	0.42	0.31	0.18	0.74	n/a	n/a	n/a
9 (229)	0.72	0.67	0.63	0.58	0.89	0.46	0.34	0.20	0.65	0.57	0.56	0.54	0.89	0.28	0.21	0.12	0.89	0.46	0.34	0.20	0.78	n/a	n/a	n/a
10 (254)	0.74	0.69	0.64	0.58	0.97	0.50	0.37	0.21	0.67	0.58	0.56	0.55	1.00	0.32	0.24	0.15	0.97	0.50	0.37	0.21	0.83	n/a	n/a	n/a
11 (279)	0.76	0.70	0.65	0.59	1.00	0.54	0.40	0.23	0.69	0.59	0.57	0.55		0.37	0.28	0.17	1.00	0.54	0.40	0.23	0.87	n/a	n/a	n/a
11-1/4 (286)	0.77	0.71	0.66	0.59		0.56	0.41	0.24	0.69	0.59	0.57	0.55		0.38	0.29	0.17		0.56	0.41	0.24	0.88	0.59	n/a	n/a
12 (305)	0.79	0.72	0.67	0.60		0.59	0.44	0.26	0.70	0.59	0.58	0.56		0.42	0.32	0.19		0.59	0.44	0.26	0.91	0.61	n/a	n/a
13 (330)	0.81	0.74	0.68	0.61		0.64	0.47	0.28	0.72	0.60	0.58	0.56		0.48	0.36	0.22		0.64	0.47	0.28	0.94	0.64	n/a	n/a
14 (356)	0.84	0.76	0.69	0.62		0.69	0.51	0.30	0.74	0.61	0.59	0.56		0.53	0.40	0.24		0.69	0.51	0.30	0.98	0.66	n/a	n/a
14-1/4 (362)	0.84	0.76	0.70	0.62		0.70	0.52	0.30	0.74	0.61	0.59	0.57		0.55	0.41	0.25		0.70	0.52	0.30	0.99	0.67	0.61	n/a
16 (406)	0.88	0.80	0.72	0.63		0.79	0.58	0.34	0.77	0.63	0.60	0.57		0.65	0.49	0.29		0.79	0.58	0.34	1.00	0.71	0.64	n/a
18 (457)	0.93	0.83	0.75	0.65		0.89	0.65	0.38	0.81	0.64	0.62	0.58		0.78	0.58	0.35		0.89	0.65	0.38		0.75	0.68	n/a
20 (508)	0.98	0.87	0.78	0.67		0.99	0.73	0.43	0.84	0.66	0.63	0.59		0.91	0.68	0.41		0.99	0.73	0.43		0.79	0.72	n/a
22 (559)	1.00	0.91	0.81	0.68		1.00	0.80	0.47	0.88	0.67	0.64	0.60		1.00	0.79	0.47		1.00	0.80	0.47		0.83	0.75	n/a
22-1/4 (565)		0.91	0.81	0.69			0.81	0.47	0.88	0.67	0.64	0.60			0.80	0.48			0.81	0.47		0.84	0.76	0.64
24 (610)		0.94	0.83	0.70			0.87	0.51	0.91	0.69	0.66	0.61			0.90	0.54			0.87	0.51		0.87	0.79	0.66
26 (660)		0.98	0.86	0.72			0.94	0.55	0.94	0.70	0.67	0.62			1.00	0.61			0.94	0.55		0.90	0.82	0.69
28 (711)		1.00	0.89	0.73			1.00	0.60	0.98	0.72	0.68	0.63				0.68			1.00	0.60		0.94	0.85	0.72
30 (762)			0.92	0.75				0.64	1.00	0.74	0.69	0.64				0.75				0.64		0.97	0.88	0.74
36 (914)			1.00	0.80				0.77		0.78	0.73	0.67				0.99				0.77		1.00	0.97	0.81
>48 (1219)				0.90				1.00		0.88	0.81	0.72				1.00				1.00		1.00	0.94	0.94

Table 37 – Load adjustment factors for 1-in. diameter fractional threaded rods in cracked concrete^{1,2,3}

1 in Cracked Concrete	Spacing Factor in Tension f_{AN}				Edge Distance Factor in Tension f_{RN}				Spacing Factor in Shear ⁴ f_{AV}				Edge Distance in Shear								Conc. Thickness Factor in Shear ⁵ f_{HV}			
													⊥ Toward Edge f_{RV}				∥ To Edge f_{RV}							
Embedment h_{ef} in (mm)	4 (102)	9 (229)	12 (305)	20 (508)	4 (102)	9 (229)	12 (305)	20 (508)	4 (102)	9 (229)	12 (305)	20 (508)	4 (102)	9 (229)	12 (305)	20 (508)	4 (102)	9 (229)	12 (305)	20 (508)	4 (102)	9 (229)	12 (305)	20 (508)
1-3/4 (44)	n/a	n/a	n/a	n/a	0.44	0.42	0.40	0.38	n/a	n/a	n/a	n/a	0.09	0.04	0.03	0.02	0.17	0.08	0.06	0.03	n/a	n/a	n/a	n/a
5 (127)	0.62	0.59	0.57	0.54	0.62	0.56	0.50	0.44	0.59	0.55	0.54	0.53	0.42	0.19	0.14	0.08	0.62	0.37	0.28	0.17	n/a	n/a	n/a	n/a
6 (152)	0.64	0.61	0.58	0.55	0.69	0.60	0.53	0.46	0.61	0.57	0.55	0.54	0.55	0.24	0.18	0.11	0.69	0.49	0.37	0.22	n/a	n/a	n/a	n/a
6-1/4 (159)	0.65	0.62	0.59	0.55	0.70	0.61	0.54	0.46	0.62	0.57	0.56	0.54	0.58	0.26	0.19	0.12	0.70	0.52	0.39	0.23	0.68	n/a	n/a	n/a
7 (178)	0.67	0.63	0.60	0.56	0.75	0.65	0.57	0.47	0.63	0.58	0.56	0.54	0.69	0.31	0.23	0.14	0.75	0.61	0.46	0.28	0.72	n/a	n/a	n/a
8 (203)	0.69	0.65	0.61	0.57	0.82	0.70	0.60	0.49	0.65	0.59	0.57	0.55	0.84	0.38	0.28	0.17	0.82	0.70	0.56	0.34	0.77	n/a	n/a	n/a
9 (229)	0.72	0.67	0.63	0.58	0.89	0.75	0.64	0.51	0.67	0.60	0.58	0.56	1.00	0.45	0.34	0.20	0.89	0.75	0.64	0.40	0.82	n/a	n/a	n/a
10 (254)	0.74	0.69	0.64	0.58	0.97	0.80	0.67	0.53	0.69	0.61	0.59	0.56		0.52	0.39	0.24	0.97	0.80	0.67	0.47	0.86	n/a	n/a	n/a
11 (279)	0.76	0.70	0.65	0.59	1.00	0.86	0.71	0.55	0.70	0.62	0.60	0.57		0.60	0.45	0.27	1.00	0.86	0.71	0.54	0.90	n/a	n/a	n/a
11-1/4 (286)	0.77	0.71	0.66	0.59		0.87	0.72	0.56	0.71	0.62	0.60	0.57		0.63	0.47	0.28		0.87	0.72	0.56	0.92	0.70	n/a	n/a
12 (305)	0.79	0.72	0.67	0.60		0.91	0.75	0.57	0.72	0.63	0.61	0.58		0.69	0.52	0.31		0.91	0.75	0.57	0.95	0.72	n/a	n/a
13 (330)	0.81	0.74	0.68	0.61		0.97	0.79	0.59	0.74	0.64	0.62	0.58		0.78	0.58	0.35		0.97	0.79	0.59	0.98	0.75	n/a	n/a
14 (356)	0.84	0.76	0.69	0.62		1.00	0.83	0.62	0.76	0.65	0.63	0.59		0.87	0.65	0.39		1.00	0.83	0.62	1.00	0.78	n/a	n/a
14-1/4 (362)	0.84	0.76	0.70	0.62			0.84	0.62	0.77	0.65	0.63	0.59		0.89	0.67	0.40			0.84	0.62		0.79	0.71	n/a
16 (406)	0.88	0.80	0.72	0.63			0.91	0.66	0.80	0.67	0.64	0.60		1.00	0.80	0.48			0.91	0.66		0.83	0.76	n/a
18 (457)	0.93	0.83	0.75	0.65			1.00	0.70	0.83	0.70	0.66	0.61			0.95	0.57			1.00	0.70		0.88	0.80	n/a
20 (508)	0.98	0.87	0.78	0.67				0.75	0.87	0.72	0.68	0.63			1.00	0.67				0.75		0.93	0.85	n/a
22 (559)	1.00	0.91	0.81	0.68				0.80	0.91	0.74	0.70	0.64				0.77				0.80		0.98	0.89	n/a
22-1/4 (565)		0.91	0.81	0.69				0.80	0.91	0.74	0.70	0.64				0.78				0.80		0.98	0.89	0.75
24 (610)		0.94	0.83	0.70				0.85	0.95	0.76	0.71	0.65				0.88				0.85		1.00	0.93	0.78
26 (660)		0.98	0.86	0.72				0.90	0.98	0.78	0.73	0.67				0.99				0.90		0.96	0.81	
28 (711)		1.00	0.89	0.73				0.95	1.00	0.80	0.75	0.68				1.00				0.95		1.00	0.84	
30 (762)			0.92	0.75				1.00		0.83	0.77	0.69								1.00				0.87
36 (914)			1.00	0.80						0.89	0.82	0.73												0.96
>48 (1219)				0.90						1.00	0.93	0.81												1.00

Footnotes for Tables 36 and 37

- Linear interpolation not permitted
- Shaded area with reduced edge distance is permitted provided the installation torque is reduced to 0.30 T_{max} for 5d < s < 16-in. and to 0.5 T_{max} for s > 16-in.
- When combining multiple load adjustment factors (e.g. for a four-anchor pattern in a corner with thin concrete member) the design can become very conservative. To optimize the design, use Hilti PROFIS Anchor Design software or perform anchor calculation using design equations from ACI 318-14 Chapter 17 and CSA A23.3-14 Annex D.
- Spacing factor reduction in shear, f_{AV} , assumes an influence of a nearby edge. If no edge exists, then $f_{AV} = f_{AN}$.
- Concrete thickness reduction factor in shear, f_{HV} , assumes an influence of a nearby edge. If no edge exists, then $f_{HV} = 1.0$.

Table 38 — Load adjustment factors for 1-1/4-in. diameter fractional threaded rods in uncracked concrete ^{1,2,3}

Embedment h_{ef} in (mm)	Spacing Factor in Tension f_{AN}				Edge Distance Factor in Tension f_{RN}				Spacing Factor in Shear ⁴ f_{AV}				Edge Distance in Shear								Conc. Thickness Factor in Shear ⁵ f_{HV}			
													┌ Toward Edge f_{RV}				┐ To Edge f_{RV}							
	5 (127)	11-1/4 (286)	15 (381)	25 (635)	5 (127)	11-1/4 (286)	15 (381)	25 (635)	5 (127)	11-1/4 (286)	15 (381)	25 (635)	5 (127)	11-1/4 (286)	15 (381)	25 (635)	5 (127)	11-1/4 (286)	15 (381)	25 (635)	5 (127)	11-1/4 (286)	15 (381)	25 (635)
1-3/4 (44)	n/a	n/a	n/a	n/a	0.37	0.22	0.16	0.09	n/a	n/a	n/a	n/a	0.05	0.02	0.01	0.01	0.11	0.03	0.02	0.01	n/a	n/a	n/a	n/a
6-1/4 (159)	0.62	0.59	0.57	0.54	0.63	0.32	0.24	0.14	0.59	0.54	0.53	0.52	0.37	0.11	0.08	0.05	0.63	0.22	0.16	0.10	n/a	n/a	n/a	n/a
7 (178)	0.64	0.60	0.58	0.55	0.67	0.34	0.25	0.15	0.60	0.54	0.53	0.52	0.43	0.13	0.09	0.06	0.67	0.26	0.19	0.11	n/a	n/a	n/a	n/a
8 (203)	0.66	0.62	0.59	0.55	0.72	0.37	0.27	0.16	0.61	0.55	0.54	0.53	0.53	0.16	0.12	0.07	0.72	0.31	0.23	0.14	0.66	n/a	n/a	n/a
9 (229)	0.68	0.63	0.60	0.56	0.78	0.40	0.29	0.17	0.62	0.55	0.54	0.53	0.63	0.19	0.14	0.08	0.78	0.38	0.28	0.17	0.70	n/a	n/a	n/a
10 (254)	0.70	0.65	0.61	0.57	0.83	0.43	0.31	0.18	0.64	0.56	0.55	0.54	0.74	0.22	0.16	0.10	0.83	0.43	0.31	0.18	0.74	n/a	n/a	n/a
11 (279)	0.72	0.66	0.62	0.57	0.89	0.46	0.34	0.20	0.65	0.57	0.55	0.54	0.86	0.25	0.19	0.11	0.89	0.46	0.34	0.20	0.78	n/a	n/a	n/a
12 (305)	0.74	0.68	0.63	0.58	0.95	0.49	0.36	0.21	0.66	0.57	0.56	0.54	0.98	0.29	0.21	0.13	0.95	0.49	0.36	0.21	0.81	n/a	n/a	n/a
13 (330)	0.76	0.69	0.64	0.59	1.00	0.52	0.38	0.23	0.68	0.58	0.56	0.55	1.00	0.33	0.24	0.14	1.00	0.52	0.38	0.23	0.84	n/a	n/a	n/a
14 (356)	0.77	0.71	0.66	0.59		0.56	0.41	0.24	0.69	0.59	0.57	0.55		0.36	0.27	0.16		0.56	0.41	0.24	0.87	0.58	n/a	n/a
14-1/4 (362)	0.78	0.71	0.66	0.60		0.57	0.42	0.25	0.69	0.59	0.57	0.55		0.37	0.27	0.16		0.57	0.42	0.25	0.88	0.59	n/a	n/a
15 (381)	0.79	0.72	0.67	0.60		0.60	0.44	0.26	0.70	0.59	0.57	0.55		0.40	0.30	0.18		0.60	0.44	0.26	0.91	0.60	n/a	n/a
16 (406)	0.81	0.74	0.68	0.61		0.64	0.47	0.28	0.72	0.60	0.58	0.56		0.45	0.33	0.20		0.64	0.47	0.28	0.94	0.62	n/a	n/a
17 (432)	0.83	0.75	0.69	0.61		0.68	0.50	0.29	0.73	0.60	0.58	0.56		0.49	0.36	0.21		0.68	0.50	0.29	0.96	0.64	n/a	n/a
18 (457)	0.85	0.77	0.70	0.62		0.72	0.53	0.31	0.75	0.61	0.59	0.56		0.53	0.39	0.23		0.72	0.53	0.31	0.99	0.66	0.60	n/a
20 (508)	0.89	0.80	0.72	0.63		0.80	0.59	0.35	0.77	0.62	0.60	0.57		0.62	0.46	0.27		0.80	0.59	0.35	1.00	0.70	0.63	n/a
22 (559)	0.93	0.83	0.74	0.65		0.88	0.65	0.38	0.80	0.63	0.61	0.58		0.72	0.53	0.32		0.88	0.65	0.38		0.73	0.66	n/a
24 (610)	0.97	0.86	0.77	0.66		0.96	0.71	0.42	0.83	0.65	0.62	0.58		0.82	0.60	0.36		0.96	0.71	0.42		0.76	0.69	n/a
26 (660)	1.00	0.89	0.79	0.67		1.00	0.77	0.45	0.86	0.66	0.63	0.59		0.92	0.68	0.41		1.00	0.77	0.45		0.79	0.72	n/a
28 (711)		0.91	0.81	0.69			0.83	0.48	0.88	0.67	0.64	0.60		1.00	0.76	0.45			0.83	0.48		0.82	0.74	0.63
30 (762)		0.94	0.83	0.70			0.89	0.52	0.91	0.68	0.65	0.61			0.84	0.50			0.89	0.52		0.85	0.77	0.65
36 (914)		1.00	0.90	0.74			1.00	0.62	0.99	0.72	0.68	0.63			1.00	0.66			1.00	0.62		0.94	0.84	0.71
>48 (1219)			1.00	0.82				0.83	1.00	0.79	0.74	0.67				1.00				0.83		1.00	0.97	0.82

Table 39 — Load adjustment factors for 1-1/4-in. diameter fractional threaded rods in cracked concrete ^{1,2,3}

Embedment h_{ef} in (mm)	Spacing Factor in Tension f_{AN}				Edge Distance Factor in Tension f_{RN}				Spacing Factor in Shear ⁴ f_{AV}				Edge Distance in Shear								Conc. Thickness Factor in Shear ⁵ f_{HV}			
													┌ Toward Edge f_{RV}				┐ To Edge f_{RV}							
	5 (127)	11-1/4 (286)	15 (381)	25 (635)	5 (127)	11-1/4 (286)	15 (381)	25 (635)	5 (127)	11-1/4 (286)	15 (381)	25 (635)	5 (127)	11-1/4 (286)	15 (381)	25 (635)	5 (127)	11-1/4 (286)	15 (381)	25 (635)	5 (127)	11-1/4 (286)	15 (381)	25 (635)
1-3/4 (44)	n/a	n/a	n/a	n/a	0.42	0.40	0.39	0.37	n/a	n/a	n/a	n/a	0.07	0.03	0.02	0.01	0.13	0.06	0.04	0.03	n/a	n/a	n/a	n/a
6-1/4 (159)	0.62	0.59	0.57	0.54	0.63	0.56	0.50	0.44	0.60	0.56	0.55	0.53	0.44	0.20	0.15	0.09	0.87	0.39	0.29	0.18	n/a	n/a	n/a	n/a
7 (178)	0.64	0.60	0.58	0.55	0.67	0.58	0.52	0.45	0.61	0.56	0.55	0.54	0.52	0.23	0.17	0.10	0.95	0.46	0.35	0.21	n/a	n/a	n/a	n/a
8 (203)	0.66	0.62	0.59	0.55	0.72	0.62	0.55	0.46	0.62	0.57	0.56	0.54	0.64	0.28	0.21	0.13	1.00	0.56	0.42	0.25	0.70	n/a	n/a	n/a
9 (229)	0.68	0.63	0.60	0.56	0.78	0.66	0.57	0.48	0.64	0.58	0.57	0.55	0.76	0.34	0.25	0.15		0.66	0.51	0.30	0.74	n/a	n/a	n/a
10 (254)	0.70	0.65	0.61	0.57	0.83	0.70	0.60	0.49	0.65	0.59	0.57	0.55	0.89	0.39	0.30	0.18		0.70	0.59	0.36	0.78	n/a	n/a	n/a
11 (279)	0.72	0.66	0.62	0.57	0.89	0.74	0.63	0.51	0.67	0.60	0.58	0.56	1.00	0.46	0.34	0.20		0.74	0.63	0.41	0.82	n/a	n/a	n/a
12 (305)	0.74	0.68	0.63	0.58	0.95	0.78	0.66	0.53	0.68	0.61	0.59	0.56		0.52	0.39	0.23		0.78	0.66	0.47	0.86	n/a	n/a	n/a
13 (330)	0.76	0.69	0.64	0.59	1.00	0.82	0.69	0.54	0.70	0.62	0.60	0.57		0.59	0.44	0.26		0.82	0.69	0.53	0.89	n/a	n/a	n/a
14 (356)	0.77	0.71	0.66	0.59		0.87	0.72	0.56	0.72	0.63	0.60	0.57		0.65	0.49	0.29		0.87	0.72	0.56	0.93	0.71	n/a	n/a
14-1/4 (362)	0.78	0.71	0.66	0.60		0.88	0.73	0.56	0.72	0.63	0.61	0.58		0.67	0.50	0.30		0.88	0.73	0.56	0.94	0.71	n/a	n/a
15 (381)	0.79	0.72	0.67	0.60		0.91	0.75	0.57	0.73	0.63	0.61	0.58		0.73	0.54	0.33		0.91	0.75	0.57	0.96	0.73	n/a	n/a
16 (406)	0.81	0.74	0.68	0.61		0.96	0.78	0.59	0.75	0.64	0.62	0.58		0.80	0.60	0.36		0.96	0.78	0.59	0.99	0.76	n/a	n/a
17 (432)	0.83	0.75	0.69	0.61		1.00	0.81	0.61	0.76	0.65	0.63	0.59		0.87	0.66	0.39		1.00	0.81	0.61	1.00	0.78	n/a	n/a
18 (457)	0.85	0.77	0.70	0.62			0.85	0.62	0.78	0.66	0.63	0.59		0.95	0.71	0.43			0.85	0.62		0.80	0.73	n/a
20 (508)	0.89	0.80	0.72	0.63			0.91	0.66	0.81	0.68	0.65	0.61		1.00	0.84	0.50			0.91	0.66		0.85	0.77	n/a
22 (559)	0.93	0.83	0.74	0.65			0.98	0.69	0.84	0.70	0.66	0.62			0.97	0.58			0.98	0.69		0.89	0.81	n/a
24 (610)	0.97	0.86	0.77	0.66			1.00	0.73	0.87	0.72	0.68	0.63			1.00	0.66			1.00	0.73		0.93	0.84	n/a
26 (660)	1.00	0.89	0.79	0.67				0.77	0.90	0.73	0.69	0.64				0.74				0.77		0.97	0.88	n/a
28 (711)		0.91	0.81	0.69				0.81	0.93	0.75	0.71	0.65				0.83				0.81		1.00	0.91	0.77
30 (762)		0.94	0.83	0.70				0.85	0.96	0.77	0.72	0.66				0.92				0.85			0.94	0.79
36 (914)		1.00	0.90	0.74				0.97	1.00	0.82	0.77	0.69				1.00				0.97			1.00	0.87
>48 (1219)			1.00	0.82				1.00		0.93	0.86	0.75								1.00				1.00

Footnotes for Tables 38 and 39

- Linear interpolation not permitted
- Shaded area with reduced edge distance is permitted provided the installation torque is reduced to 0.30 T_{max} for 5d < s < 16-in. and to 0.5 T_{max} for s > 16-in.
- When combining multiple load adjustment factors (e.g. for a four-anchor pattern in a corner with thin concrete member) the design can become very conservative. To optimize the design, use Hitl PROFIS Anchor Design software or perform anchor calculation using design equations from ACI 318-14 Chapter 17 and CSA A23.3-14 Annex D.
- Spacing factor reduction in shear, f_{AV} , assumes an influence of a nearby edge. If no edge exists, then $f_{AV} = f_{AN}$.
- Concrete thickness reduction factor in shear, f_{HV} , assumes an influence of a nearby edge. If no edge exists, then $f_{HV} = 1.0$.

2.4.10 CANADIAN LIMIT STATE DESIGN

Limit State Design of anchors is described in the provisions of CSA A23.3 -14 (2014) Annex D for post-installed anchors tested and assessed in accordance with ACI 355.2 for mechanical anchors and ACI 355.4 for adhesive anchors. This section contains the Limit State Design tables with unfactored characteristic loads that are based on the published loads in ICC Evaluation Services ESR-3829. These tables are followed by factored resistance tables. The factored resistance tables have characteristic design loads that are prefactored by the applicable reduction factors for a single anchor with no anchor-to-anchor spacing or edge distance adjustments for the convenience of the user of this document. All the figures in the previous ACI 318-14 Chapter 17 design section are applicable to Limit State Design and the tables will reference these figures.

For a detailed explanation of the tables developed in accordance with CSA A23.3-14 (2014) Annex D, refer to Section 3.1.8. Technical assistance is available by contacting Hilti Canada at (800) 363-4458 or at www.hilti.ca

Table 40 – Specifications for CA Rebar installed with HIT-RE 100



Setting information	Symbol	Units	Rebar Size				
			10 M	15 M	20 M	25 M	30 M
Nominal bit diameter	d_o	mm	11.3	16.0	19.5	25.2	29.9
Effective Embedment	minimum	$h_{ef,min}$	60	80	90	100	120
	maximum	$h_{ef,max}$	226	320	390	504	598
Minimum Concrete Thickness	h_{min}	mm.	$h_{ef} + 30$	$h_{ef} + 2d_o$			

Table 41 – Specifications for CA Rebar installed with HIT-RE 100

Rebar Size	CSA-G30.18 Grade 400 ²		
	Tensile ³ N_{sar} lb (kN)	Shear ⁴ V_{sar} lb (kN)	Seismic shear ⁵ $V_{sar,eq}$ lb (kN)
10 M	7,245 (32.2)	4,035 (17.9)	2,825 (12.6)
15 M	14,525 (64.6)	8,090 (36.0)	5,665 (25.2)
20 M	21,570 (95.9)	12,020 (53.5)	8,415 (37.4)
25 M	36,025 (160.2)	20,070 (89.3)	14,050 (62.5)
30 M	50,715 (225.6)	28,255 (125.7)	19,780 (88.0)

- 1 See Section 3.1.8.6 (PTG) to convert design strength value to ASD value.
- 2 CSA-G30.18 Grade 400 rebar are considered ductile steel elements.
- 3 Tensile = $A_{sar,N} \phi_s f_{uts}$ R as noted in CSA A23.3-14 Annex D
- 4 Shear = $A_{sar,V} \phi_s 0.60 f_{uts}$ R as noted in CSA A23.3-14 Annex D.
- 5 Seismic Shear = $\alpha_{V,seis} V_{sar}$: Reduction factor for seismic shear only.
See section 3.1.8.7 (2019 PTG) for additional information on seismic applications.



Table 42 — Hilti HIT-RE 100 adhesive design information with CA rebar in hammer drilled holes in accordance with CSA A23.3-14 Annex D 1,9

Design parameter	Symbol	Units	Rebar Size					Ref A23.3-14	
			10 M	15 M	20 M	25 M	30 M		
Anchor O.D.	d_a	mm	11.3	16.0	19.5	25.2	29.9		
Effective minimum embedment ²	h_{ef}	mm	60	80	90	101	120		
Effective maximum embedment ²	h_{ef}	mm	226	320	390	504	598		
Minimum concrete thickness ²	h_{min}	mm	$h_{ef} + 30$	$h_{ef} + 2d_o$					
Critical edge distance	c_{ac}	mm	See ESR-3829, section 4.1.10						
Minimum edge distance	c_{min}^3	mm	57	80	98	126	150		
Minimum anchor spacing	s_{min}	mm	57	80	98	126	150		
Coeff. for factored conc. breakout resistance, uncracked concrete	$k_{c,uncr}^4$	-	10					D.6.2.2	
Coeff. for factored conc. breakout resistance, cracked concrete	$k_{c,cr}^4$	-	7					D.6.2.2	
Concrete material resistance factor	ϕ_c	-	0.65					8.4.2	
Resistance modification factor for tension and shear, concrete failure modes, Condition B ⁵	R_{conc}	-	1.00					D.5.3 (c)	
Dry Concrete									
Temp. range A ⁶	Characteristic bond stress in cracked concrete ^{7,8}	T_{cr}	psi (MPa)	476 (3.3)	476 (3.3)	476 (3.3)	476 (3.3)	416 (2.9)	D.6.5.2
	Characteristic bond stress in uncracked concrete ^{7,8}	T_{uncr}	psi (MPa)	1,272 (8.8)	1,204 (8.3)	1,156 (8.0)	1,100 (7.6)	1,056 (7.3)	D.6.5.2
Anchor category, dry concrete	-	-	-	2	2	2	2	2	D.5.3 (c)
Resistance modification factor	R_{dry}	-	-	0.85	0.85	0.85	0.85	0.85	
Water Saturated Concrete									
Temp. range A ⁶	Characteristic bond stress in cracked concrete ^{7,8}	T_{cr}	psi (MPa)	424 (2.9)	420 (2.9)	405 (2.8)	360 (2.5)	319 (2.2)	D.6.5.2
	Characteristic bond stress in uncracked concrete ^{7,8}	T_{uncr}	psi (MPa)	1,133 (7.8)	1,061 (7.3)	986 (6.8)	878 (6.1)	803 (5.5)	D.6.5.2
Anchor category, water-saturated concrete	-	-	-	3	3	3	3	3	D.5.3 (c)
Resistance modification factor	R_{ws}	-	-	0.75	0.75	0.75	0.75	0.75	
Water-Filled Hole									
Temp. range A ⁶	Characteristic bond stress in cracked concrete ^{7,8}	T_{cr}	psi (MPa)	424 (2.9)	420 (2.9)	405 (2.8)	360 (2.5)	319 (2.2)	D.6.5.2
	Characteristic bond stress in uncracked concrete ^{7,8}	T_{uncr}	psi (MPa)	1,133 (7.8)	1,061 (7.3)	986 (6.8)	878 (6.1)	803 (5.5)	D.6.5.2
Anchor category, water-filled hole	-	-	-	3	3	3	3	3	D.5.3 (c)
Resistance modification factor	R_{wf}	-	-	0.75	0.75	0.75	0.75	0.75	
Underwater Application									
Temp. range A ⁶	Characteristic bond stress in cracked concrete ^{7,8}	T_{cr}	psi (MPa)	424 (2.9)	420 (2.9)	405 (2.8)	360 (2.5)	319 (2.2)	D.6.5.2
	Characteristic bond stress in uncracked concrete ^{7,8}	T_{uncr}	psi (MPa)	1,133 (7.8)	1,061 (7.3)	986 (6.8)	878 (6.1)	803 (5.5)	D.6.5.2
Anchor category, underwater	-	-	-	3	3	3	3	3	D.5.3 (c)
Resistance modification factor	R_{uw}	-	-	0.75	0.75	0.75	0.75	0.75	

Figure 3 — HAS threaded rods

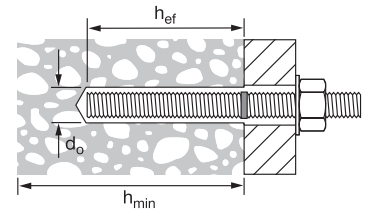

1 Design information in this table is taken from ICC-ES ESR-3829, dated September, 2019, table 32 and 33, and converted for use with CSA A23.3-14 Annex D.

2 See figure 3.

3 Minimum edge distance may be reduced to 45mm provided rebar remains untorqued. See ESR-3829 section 4.1.9.

4 For all design cases, $\psi_{c,N} = 1.0$. The appropriate coefficient for breakout resistance for cracked concrete ($k_{c,cr}$) or uncracked concrete ($k_{c,uncr}$) must be used.

5 For use with the load combinations of CSA A23.3-14 chapter 8. Condition B applies where supplementary reinforcement in conformance with CSA A23.3-14 section D.5.3 is not provided, or where pullout or pryout strength governs. For cases where the presence of supplementary reinforcement can be verified, the resistance modification factors associated with Condition A may be used.

6 Temperature range A: Max. short term temperature = 130°F (55°C), max. long term temperature = 110°F (43°C).

Short term elevated concrete temperatures are those that occur over brief intervals, e.g., as a result of diurnal cycling. Long term concrete temperatures are roughly constant over significant periods of time.

7 Bond strength values corresponding to concrete compressive strength $f'_c = 2,500$ psi (17.2 MPa). For concrete compressive strength, f'_c , between 2,500 psi (17.2 MPa) and 8,000 psi (55.2 MPa), the tabulated characteristic bond strength may be increased by a factor of $(f'_c/2,500)^{0.1}$ [for SI: $(f'_c/17.2)^{0.1}$].

8 Bond strength values are for sustained loads including dead and live loads. For load combinations consisting of short-term loads only such as wind and seismic, bond strengths may be increased by 40 percent.

9 For structures assigned to Seismic Design Categories C, D, E, or F, bond strength values must be multiplied by $\alpha_{N,seis} = 0.9$.

Table 43 — Hilti HIT-RE 100 adhesive factored resistance with concrete / bond failure for CA rebar in uncracked concrete ^{1,2,3,4,5,6,7,8,9,10}



Rebar Size	Effective Embedment Depth in. (mm)	Tension — N_r				Shear — V_r			
		$f'_c = 20$ MPa (2,900 psi) lb (kN)	$f'_c = 25$ MPa (3,625 psi) lb (kN)	$f'_c = 30$ MPa (4,350 psi) lb (kN)	$f'_c = 40$ MPa (5,800 psi) lb (kN)	$f'_c = 20$ MPa (2,900 psi) lb (kN)	$f'_c = 25$ MPa (3,625 psi) lb (kN)	$f'_c = 30$ MPa (4,350 psi) lb (kN)	$f'_c = 40$ MPa (5,800 psi) lb (kN)
10 M	4-1/2 (115)	4,515 (20.1)	4,620 (20.5)	4,705 (20.9)	4,840 (21.5)	9,030 (40.2)	9,235 (41.1)	9,405 (41.8)	9,680 (43.1)
	7-1/16 (180)	7,070 (31.4)	7,230 (32.2)	7,360 (32.7)	7,575 (33.7)	14,135 (62.9)	14,455 (64.3)	14,720 (65.5)	15,150 (67.4)
	8-7/8 (226)	8,875 (39.5)	9,075 (40.4)	9,240 (41.1)	9,510 (42.3)	17,750 (79.0)	18,150 (80.7)	18,485 (82.2)	19,025 (84.6)
15 M	5-11/16 (145)	7,630 (33.9)	7,805 (34.7)	7,945 (35.3)	8,180 (36.4)	15,260 (67.9)	15,605 (69.4)	15,895 (70.7)	16,360 (72.8)
	9-13/16 (250)	13,155 (58.5)	13,455 (59.8)	13,700 (60.9)	14,100 (62.7)	26,315 (117.1)	26,910 (119.7)	27,405 (121.9)	28,205 (125.5)
	12-5/8 (320)	16,840 (74.9)	17,220 (76.6)	17,540 (78.0)	18,050 (80.3)	33,685 (149.8)	34,445 (153.2)	35,075 (156.0)	36,100 (160.6)
20 M	7-7/8 (200)	12,315 (54.8)	12,595 (56.0)	12,825 (57.1)	13,200 (58.7)	24,635 (109.6)	25,190 (112.0)	25,655 (114.1)	26,400 (117.4)
	14 (355)	21,865 (97.2)	22,355 (99.4)	22,765 (101.3)	23,430 (104.2)	43,725 (194.5)	44,710 (198.9)	45,535 (202.5)	46,865 (208.5)
	15-3/8 (390)	24,020 (106.8)	24,560 (109.2)	25,010 (111.3)	25,740 (114.5)	48,035 (213.7)	49,120 (218.5)	50,025 (222.5)	51,485 (229.0)
25 M	9-1/16 (230)	17,420 (77.5)	17,810 (79.2)	18,140 (80.7)	18,670 (83.0)	34,835 (155.0)	35,620 (158.5)	36,280 (161.4)	37,335 (166.1)
	15-15/16 (405)	30,670 (136.4)	31,365 (139.5)	31,940 (142.1)	32,870 (146.2)	61,340 (272.9)	62,725 (279.0)	63,880 (284.2)	65,745 (292.4)
	19-13/16 (504)	38,170 (169.8)	39,030 (173.6)	39,750 (176.8)	40,910 (182.0)	76,335 (339.6)	78,060 (347.2)	79,495 (353.6)	81,815 (363.9)
30 M	10-1/4 (260)	22,430 (99.8)	22,935 (102.0)	23,355 (103.9)	24,040 (106.9)	44,855 (199.5)	45,870 (204.0)	46,710 (207.8)	48,075 (213.8)
	17-15/16 (455)	39,250 (174.6)	40,135 (178.5)	40,875 (181.8)	42,065 (187.1)	78,500 (349.2)	80,270 (357.1)	81,745 (363.6)	84,130 (374.2)
	23-9/16 (598)	51,585 (229.5)	52,750 (234.6)	53,720 (239.0)	55,285 (245.9)	103,170 (458.9)	105,495 (469.3)	107,435 (477.9)	110,575 (491.9)

- 1 See Section 3.1.8 (2019 PTG) for explanation on development of load values.
- 2 See Section 3.1.8.6 (2019 PTG) to convert design strength value to ASD value.
- 3 Linear interpolation between embedment depths and concrete compressive strengths is not permitted.
- 4 Apply spacing, edge distance, and concrete thickness factors in tables 5-20 as necessary. Compare to the steel values in table 40. The lesser of the values is to be used for the design.
- 5 Values are for the following temperature range: maximum short term temperature = 130°F (55°C), maximum long term temperature = 110°F (43°C). Short term elevated concrete temperatures are those that occur over brief intervals, e.g., as a result of diurnal cycling. Long term concrete temperatures are roughly constant over significant periods of time.
- 6 Tabular values are for dry concrete conditions. For water saturated concrete, water-filled drilled holes, or submerged (underwater) applications multiply design strength by 0.61.
- 7 Tabular values are for short term loads only. For sustained loads including overhead use, see Section 3.1.8.8 (2019 PTG).
- 8 Tabular values are for normal-weight concrete only. For lightweight concrete multiply design strength by λ_a as follows:
For sand-lightweight, $\lambda_a = 0.51$. For all-lightweight, $\lambda_a = 0.45$.
- 9 Tabular values are for holes drilled in concrete with carbide tipped hammer drill bit. Diamond core drilling is not permitted.
- 10 Tabular values are for static loads only. Seismic design is not permitted for uncracked concrete.

Table 44 — Hilti HIT-RE 100 adhesive factored resistance with concrete / bond failure for CA rebar in cracked concrete ^{1,2,3,4,5,6,7,8,9,10}



Rebar Size	Effective Embedment Depth in. (mm)	Tension — N_t				Shear — V_r			
		$f'_c = 20$ MPa (2,900 psi) lb (kN)	$f'_c = 25$ MPa (3,625 psi) lb (kN)	$f'_c = 30$ MPa (4,350 psi) lb (kN)	$f'_c = 40$ MPa (5,800 psi) lb (kN)	$f'_c = 20$ MPa (2,900 psi) lb (kN)	$f'_c = 25$ MPa (3,625 psi) lb (kN)	$f'_c = 30$ MPa (4,350 psi) lb (kN)	$f'_c = 40$ MPa (5,800 psi) lb (kN)
10 M	4-1/2 (115)	1,690 (7.5)	1,730 (7.7)	1,760 (7.8)	1,810 (8.1)	3,380 (15.0)	3,455 (15.4)	3,520 (15.7)	3,620 (16.1)
	7-1/16 (180)	2,645 (11.8)	2,705 (12.0)	2,755 (12.3)	2,835 (12.6)	5,290 (23.5)	5,410 (24.1)	5,510 (24.5)	5,670 (25.2)
	8-7/8 (226)	3,320 (14.8)	3,395 (15.1)	3,460 (15.4)	3,560 (15.8)	6,640 (29.5)	6,790 (30.2)	6,915 (30.8)	7,120 (31.7)
15 M	5-11/16 (145)	3,015 (13.4)	3,085 (13.7)	3,140 (14.0)	3,235 (14.4)	6,035 (26.8)	6,170 (27.4)	6,285 (28.0)	6,465 (28.8)
	9-13/16 (250)	5,200 (23.1)	5,320 (23.7)	5,415 (24.1)	5,575 (24.8)	10,405 (46.3)	10,640 (47.3)	10,835 (48.2)	11,150 (49.6)
	12-5/8 (320)	6,660 (29.6)	6,810 (30.3)	6,935 (30.8)	7,135 (31.7)	13,315 (59.2)	13,615 (60.6)	13,865 (61.7)	14,270 (63.5)
20 M	7-7/8 (200)	5,070 (22.6)	5,185 (23.1)	5,280 (23.5)	5,435 (24.2)	10,145 (45.1)	10,370 (46.1)	10,565 (47.0)	10,870 (48.4)
	14 (355)	9,000 (40.0)	9,205 (40.9)	9,375 (41.7)	9,650 (42.9)	18,005 (80.1)	18,410 (81.9)	18,750 (83.4)	19,295 (85.8)
	15-3/8 (390)	9,890 (44.0)	10,115 (45.0)	10,300 (45.8)	10,600 (47.1)	19,780 (88.0)	20,225 (90.0)	20,600 (91.6)	21,200 (94.3)
25 M	9-1/16 (230)	7,535 (33.5)	7,705 (34.3)	7,850 (34.9)	8,080 (35.9)	15,075 (67.1)	15,415 (68.6)	15,700 (69.8)	16,155 (71.9)
	15-15/16 (405)	13,270 (59.0)	13,570 (60.4)	13,820 (61.5)	14,225 (63.3)	26,545 (118.1)	27,145 (120.7)	27,645 (123.0)	28,450 (126.5)
	19-13/16 (504)	16,515 (73.5)	16,890 (75.1)	17,200 (76.5)	17,700 (78.7)	33,035 (146.9)	33,780 (150.3)	34,400 (153.0)	35,405 (157.5)
30 M	10-1/4 (260)	8,835 (39.3)	9,035 (40.2)	9,200 (40.9)	9,470 (42.1)	17,670 (78.6)	18,070 (80.4)	18,400 (81.9)	18,940 (84.2)
	17-15/16 (455)	15,460 (68.8)	15,810 (70.3)	16,100 (71.6)	16,570 (73.7)	30,925 (137.6)	31,620 (140.7)	32,205 (143.2)	33,145 (147.4)
	23-9/16 (598)	20,320 (90.4)	20,780 (92.4)	21,160 (94.1)	21,780 (96.9)	40,640 (180.8)	41,560 (184.9)	42,325 (188.3)	43,560 (193.8)

- 1 See Section 3.1.8 (2019 PTG) for explanation on development of load values.
- 2 See Section 3.1.8.6 (2019 PTG) to convert design strength value to ASD value.
- 3 Linear interpolation between embedment depths and concrete compressive strengths is not permitted.
- 4 Apply spacing, edge distance, and concrete thickness factors in tables 5-20 as necessary. Compare to the steel values in table 40. The lesser of the values is to be used for the design.
- 5 Values are for the following temperature range: maximum short term temperature = 130°F (55°C), maximum long term temperature = 110°F (43°C). Short term elevated concrete temperatures are those that occur over brief intervals, e.g., as a result of diurnal cycling. Long term concrete temperatures are roughly constant over significant periods of time.
- 6 Tabular values are for dry concrete conditions. For water saturated concrete, water-filled drilled holes, or submerged (underwater) applications multiply design strength by 0.61.
- 7 Tabular values are for short term loads only. For sustained loads including overhead use, see Section 3.1.8.8 (2019 PTG).
- 8 Tabular values are for normal-weight concrete only. For lightweight concrete multiply design strength by λ_a as follows:
For sand-lightweight, $\lambda_a = 0.51$. For all-lightweight, $\lambda_a = 0.45$.
- 9 Tabular values are for holes drilled in concrete with carbide tipped hammer drill bit. Diamond core drilling is not permitted.
- 10 Tabular values are for static loads only. For seismic loads, multiply cracked concrete tabular values in tension and shear by $\alpha_{seis} = 0.675$. See section 3.1.8.7 (2019 PTG) for additional information on seismic applications

Table 45 – Load adjustment factors for 10M rebar in uncracked concrete^{1,2,3}

10 M Uncracked Concrete	Spacing Factor in Tension f_{AN}			Edge Distance Factor in Tension f_{RN}			Spacing Factor in Shear ⁴ f_{AV}			Edge Distance in Shear						Concrete Thickness Factor in Shear ⁵ f_{HV}		
										⊥ Toward Edge f_{RV}			∥ To Edge f_{RV}					
	Embedment h_{ef} in (mm)	4-1/2 (115)	7-1/16 (180)	8-7/8 (226)	4-1/2 (115)	7-1/16 (180)	8-7/8 (226)	4-1/2 (115)	7-1/16 (180)	8-8/9 (226)	4-1/2 (115)	7-1/16 (180)	8-7/8 (226)	4-1/2 (115)	7-1/16 (180)	8-7/8 (226)	4-1/2 (115)	7-1/16 (180)
1-3/4 (44)	n/a	n/a	n/a	0.25	0.16	0.12	n/a	n/a	n/a	0.09	0.06	0.05	0.18	0.12	0.09	n/a	n/a	n/a
2-3/16 (55)	0.58	0.55	0.54	0.28	0.17	0.13	0.54	0.53	0.53	0.12	0.08	0.06	0.25	0.16	0.13	n/a	n/a	n/a
3 (76)	0.61	0.57	0.56	0.33	0.20	0.16	0.56	0.54	0.54	0.20	0.13	0.10	0.33	0.20	0.16	n/a	n/a	n/a
4 (102)	0.65	0.59	0.57	0.39	0.24	0.19	0.58	0.56	0.55	0.31	0.20	0.16	0.39	0.24	0.19	n/a	n/a	n/a
5 (127)	0.68	0.62	0.59	0.46	0.29	0.23	0.60	0.57	0.56	0.43	0.28	0.22	0.46	0.29	0.23	n/a	n/a	n/a
5-11/16 (145)	0.71	0.63	0.61	0.53	0.33	0.26	0.61	0.58	0.57	0.53	0.34	0.27	0.53	0.33	0.26	0.66	n/a	n/a
6 (152)	0.72	0.64	0.61	0.56	0.35	0.27	0.61	0.59	0.57	0.57	0.37	0.29	0.56	0.35	0.27	0.68	n/a	n/a
7 (178)	0.76	0.66	0.63	0.65	0.40	0.32	0.63	0.60	0.59	0.72	0.46	0.37	0.65	0.40	0.32	0.73	n/a	n/a
8 (203)	0.79	0.69	0.65	0.74	0.46	0.36	0.65	0.61	0.60	0.88	0.56	0.45	0.74	0.46	0.36	0.78	n/a	n/a
8-1/4 (210)	0.80	0.69	0.65	0.77	0.48	0.38	0.66	0.62	0.60	0.92	0.59	0.47	0.77	0.48	0.38	0.80	0.69	n/a
9 (229)	0.83	0.71	0.67	0.84	0.52	0.41	0.67	0.63	0.61	1.00	0.67	0.53	0.84	0.52	0.41	0.83	0.71	n/a
10-1/16 (256)	0.87	0.74	0.69	0.94	0.58	0.46	0.69	0.64	0.62		0.80	0.63	0.94	0.58	0.46	0.88	0.76	0.70
11 (279)	0.90	0.76	0.71	1.00	0.63	0.50	0.71	0.66	0.63		0.91	0.72	1.00	0.63	0.50	0.92	0.79	0.73
12 (305)	0.94	0.78	0.72		0.69	0.54	0.73	0.67	0.65		1.00	0.82		0.69	0.54	0.96	0.83	0.77
14 (356)	1.00	0.83	0.76		0.81	0.64	0.77	0.70	0.67			1.00		0.81	0.64	1.00	0.89	0.83
16 (406)		0.88	0.80		0.92	0.73	0.81	0.73	0.70					0.92	0.73		0.95	0.88
18 (457)		0.92	0.84		1.00	0.82	0.84	0.76	0.72					1.00	0.82		1.00	0.94
24 (610)		1.00	0.95			1.00	0.96	0.84	0.79						1.00			1.00
30 (762)			1.00				1.00	0.93	0.87									
36 (914)								1.00	0.94									
>48 (1219)									1.00									

Table 46 – Load adjustment factors for 10M rebar in cracked concrete^{1,2,3}

10 M Cracked Concrete	Spacing Factor in Tension f_{AN}			Edge Distance Factor in Tension f_{RN}			Spacing Factor in Shear ⁴ f_{AV}			Edge Distance in Shear						Concrete Thickness Factor in Shear ⁵ f_{HV}		
										⊥ Toward Edge f_{RV}			∥ To Edge f_{RV}					
	Embedment h_{ef} in (mm)	4-1/2 (115)	7-1/16 (180)	8-7/8 (226)	4-1/2 (115)	7-1/16 (180)	8-7/8 (226)	4-1/2 (115)	7-1/16 (180)	8-8/9 (226)	4-1/2 (115)	7-1/16 (180)	8-7/8 (226)	4-1/2 (115)	7-1/16 (180)	8-7/8 (226)	4-1/2 (115)	7-1/16 (180)
1-3/4 (44)	n/a	n/a	n/a	0.49	0.44	0.42	n/a	n/a	n/a	0.17	0.11	0.09	0.34	0.22	0.17	n/a	n/a	n/a
2-3/16 (55)	0.58	0.55	0.54	0.52	0.46	0.43	0.56	0.55	0.54	0.24	0.15	0.12	0.47	0.30	0.24	n/a	n/a	n/a
3 (76)	0.61	0.57	0.56	0.60	0.50	0.47	0.59	0.57	0.56	0.39	0.25	0.20	0.60	0.49	0.39	n/a	n/a	n/a
4 (102)	0.65	0.59	0.57	0.70	0.56	0.51	0.62	0.59	0.58	0.59	0.38	0.30	0.70	0.56	0.51	n/a	n/a	n/a
5 (127)	0.68	0.62	0.59	0.80	0.62	0.56	0.65	0.61	0.59	0.83	0.53	0.42	0.80	0.62	0.56	n/a	n/a	n/a
5-11/16 (145)	0.71	0.63	0.61	0.88	0.66	0.59	0.67	0.62	0.61	1.00	0.65	0.52	0.88	0.66	0.59	0.82	n/a	n/a
6 (152)	0.72	0.64	0.61	0.91	0.68	0.61	0.68	0.63	0.61		0.70	0.56	0.91	0.68	0.61	0.84	n/a	n/a
7 (178)	0.76	0.66	0.63	1.00	0.74	0.65	0.71	0.65	0.63		0.88	0.70	1.00	0.74	0.65	0.91	n/a	n/a
8 (203)	0.79	0.69	0.65		0.81	0.70	0.74	0.67	0.65		1.00	0.85		0.81	0.70	0.97	n/a	n/a
8-1/4 (210)	0.80	0.69	0.65		0.83	0.72	0.74	0.68	0.66			0.90		0.83	0.72	0.99	0.85	n/a
9 (229)	0.83	0.71	0.67		0.88	0.76	0.77	0.70	0.67			1.00		0.88	0.76	1.00	0.89	n/a
10-1/16 (256)	0.87	0.74	0.69		0.96	0.81	0.80	0.72	0.69					0.96	0.81		0.94	0.87
11 (279)	0.90	0.76	0.71		1.00	0.86	0.82	0.74	0.71					1.00	0.86		0.98	0.91
12 (305)	0.94	0.78	0.72			0.92	0.85	0.76	0.73						0.92		1.00	0.95
14 (356)	1.00	0.83	0.76			1.00	0.91	0.81	0.76						1.00			1.00
16 (406)		0.88	0.80				0.97	0.85	0.80									
18 (457)		0.92	0.84				1.00	0.89	0.84									
24 (610)		1.00	0.95					1.00	0.95									
30 (762)			1.00						1.00									
36 (914)																		
>48 (1219)																		

Footnotes for Tables 45 and 46

- Linear interpolation not permitted
- Shaded area with reduced edge distance is permitted provided rebar has no installation torque.
- When combining multiple load adjustment factors (e.g. for a four-anchor pattern in a corner with thin concrete member) the design can become very conservative. To optimize the design, use Hilti PROFIS Anchor Design software or perform anchor calculation using design equations from CSA A23.3-14 Annex D.
- Spacing factor reduction in shear, f_{AV} , assumes an influence of a nearby edge. If no edge exists, then $f_{AV} = f_{AN}$.
- Concrete thickness reduction factor in shear, f_{HV} , assumes an influence of a nearby edge. If no edge exists, then $f_{HV} = 1.0$.



Table 47 — Load adjustment factors for 15M rebar in uncracked concrete ^{1,2,3}

15 M Uncracked Concrete	Spacing Factor in Tension			Edge Distance Factor in Tension			Spacing Factor in Shear ⁴			Edge Distance in Shear						Concrete Thickness Factor in Shear ⁵		
	f_{AN}			f_{RN}			f_{AV}			⊥ Toward Edge f_{RV}			∥ To Edge f_{RV}			f_{HV}		
	Embedment h_{ef} in (mm)	5-11/16 (145)	9-13/16 (250)	12-5/8 (320)	5-11/16 (145)	9-13/16 (250)	12-5/8 (320)	5-11/16 (145)	9-13/16 (250)	12-5/8 (320)	5-11/16 (145)	9-13/16 (250)	12-5/8 (320)	5-11/16 (145)	9-13/16 (250)	12-5/8 (320)	5-11/16 (145)	9-13/16 (250)
1-3/4 (44)	n/a	n/a	n/a	0.25	0.14	0.11	n/a	n/a	n/a	0.06	0.04	0.03	0.13	0.07	0.06	n/a	n/a	n/a
3-1/8 (80)	0.59	0.55	0.54	0.32	0.18	0.14	0.55	0.53	0.53	0.15	0.09	0.07	0.31	0.18	0.14	n/a	n/a	n/a
4 (102)	0.62	0.57	0.55	0.36	0.20	0.16	0.56	0.54	0.54	0.22	0.13	0.10	0.36	0.20	0.16	n/a	n/a	n/a
5 (127)	0.65	0.58	0.57	0.41	0.23	0.18	0.58	0.55	0.54	0.31	0.18	0.14	0.41	0.23	0.18	n/a	n/a	n/a
6 (152)	0.68	0.60	0.58	0.47	0.26	0.20	0.59	0.56	0.55	0.40	0.23	0.18	0.47	0.26	0.20	n/a	n/a	n/a
7 (178)	0.70	0.62	0.59	0.53	0.30	0.23	0.61	0.57	0.56	0.51	0.29	0.23	0.53	0.30	0.23	n/a	n/a	n/a
7-1/4 (184)	0.71	0.62	0.60	0.55	0.31	0.24	0.61	0.58	0.56	0.53	0.31	0.24	0.55	0.31	0.24	0.66	n/a	n/a
8 (203)	0.73	0.64	0.61	0.60	0.34	0.26	0.62	0.58	0.57	0.62	0.36	0.28	0.60	0.34	0.26	0.70	n/a	n/a
9 (229)	0.76	0.65	0.62	0.68	0.38	0.29	0.64	0.59	0.58	0.74	0.43	0.34	0.68	0.38	0.29	0.74	n/a	n/a
10 (254)	0.79	0.67	0.63	0.75	0.42	0.33	0.65	0.61	0.59	0.87	0.50	0.39	0.75	0.42	0.33	0.78	n/a	n/a
11-3/8 (289)	0.83	0.69	0.65	0.86	0.48	0.37	0.67	0.62	0.60	1.00	0.61	0.48	0.86	0.48	0.37	0.83	0.69	n/a
12 (305)	0.85	0.70	0.66	0.90	0.51	0.39	0.68	0.63	0.61		0.66	0.52	0.90	0.51	0.39	0.85	0.71	n/a
14-1/8 (359)	0.91	0.74	0.69	1.00	0.60	0.46	0.71	0.65	0.63		0.84	0.66	1.00	0.60	0.46	0.93	0.77	0.71
16 (406)	0.97	0.77	0.71		0.68	0.52	0.74	0.67	0.64		1.00	0.79		0.68	0.52	0.98	0.82	0.76
18 (457)	1.00	0.80	0.74		0.76	0.59	0.77	0.69	0.66			0.95		0.76	0.59	1.00	0.87	0.80
20 (508)		0.84	0.76		0.84	0.65	0.80	0.71	0.68			1.00		0.84	0.65		0.92	0.85
22 (559)		0.87	0.79		0.93	0.72	0.83	0.73	0.70					0.93	0.72		0.96	0.89
24 (610)		0.91	0.82		1.00	0.78	0.86	0.75	0.71					1.00	0.78		1.00	0.93
30 (762)		1.00	0.90			0.98	0.95	0.82	0.77						0.98			1.00
36 (914)			0.98			1.00	1.00	0.88	0.82						1.00			
>48 (1219)			1.00					1.00	0.93									

Table 48 — Load adjustment factors for 15M rebar in cracked concrete ^{1,2,3}



15 M Cracked Concrete	Spacing Factor in Tension			Edge Distance Factor in Tension			Spacing Factor in Shear ⁴			Edge Distance in Shear						Concrete Thickness Factor in Shear ⁵		
	f_{AN}			f_{RN}			f_{AV}			⊥ Toward Edge f_{RV}			∥ To Edge f_{RV}			f_{HV}		
	Embedment h_{ef} in (mm)	5-11/16 (145)	9-13/16 (250)	12-5/8 (320)	5-11/16 (145)	9-13/16 (250)	12-5/8 (320)	5-11/16 (145)	9-13/16 (250)	12-5/8 (320)	5-11/16 (145)	9-13/16 (250)	12-5/8 (320)	5-11/16 (145)	9-13/16 (250)	12-5/8 (320)	5-11/16 (145)	9-13/16 (250)
1-3/4 (44)	n/a	n/a	n/a	0.46	0.41	0.40	n/a	n/a	n/a	0.11	0.07	0.05	0.23	0.13	0.10	n/a	n/a	n/a
3-1/8 (80)	0.59	0.55	0.54	0.55	0.46	0.44	0.57	0.55	0.54	0.28	0.16	0.13	0.55	0.32	0.25	n/a	n/a	n/a
4 (102)	0.62	0.57	0.55	0.62	0.50	0.46	0.59	0.56	0.55	0.40	0.23	0.18	0.62	0.46	0.36	n/a	n/a	n/a
5 (127)	0.65	0.58	0.57	0.69	0.54	0.49	0.61	0.58	0.57	0.55	0.32	0.25	0.69	0.54	0.49	n/a	n/a	n/a
6 (152)	0.68	0.60	0.58	0.77	0.58	0.52	0.63	0.59	0.58	0.73	0.42	0.33	0.77	0.58	0.52	n/a	n/a	n/a
7 (178)	0.70	0.62	0.59	0.86	0.62	0.56	0.66	0.61	0.59	0.92	0.53	0.42	0.86	0.62	0.56	n/a	n/a	n/a
7-1/4 (184)	0.71	0.62	0.60	0.88	0.63	0.56	0.66	0.61	0.60	0.96	0.56	0.44	0.88	0.63	0.56	0.81	n/a	n/a
8 (203)	0.73	0.64	0.61	0.95	0.66	0.59	0.68	0.63	0.61	1.00	0.65	0.51	0.95	0.66	0.59	0.85	n/a	n/a
9 (229)	0.76	0.65	0.62	1.00	0.71	0.62	0.70	0.64	0.62		0.78	0.61	1.00	0.71	0.62	0.90	n/a	n/a
10 (254)	0.79	0.67	0.63		0.76	0.66	0.72	0.66	0.63		0.91	0.71		0.76	0.66	0.95	n/a	n/a
11-3/8 (289)	0.83	0.69	0.65		0.82	0.71	0.76	0.68	0.65		1.00	0.86		0.82	0.71	1.00	0.84	n/a
12 (305)	0.85	0.70	0.66		0.86	0.73	0.77	0.69	0.66			0.93		0.86	0.73		0.87	n/a
14-1/8 (359)	0.91	0.74	0.69		0.97	0.81	0.82	0.72	0.69			1.00		0.97	0.81		0.94	0.87
16 (406)	0.97	0.77	0.71		1.00	0.88	0.86	0.75	0.71					1.00	0.88		1.00	0.92
18 (457)	1.00	0.80	0.74			0.96	0.90	0.78	0.74						0.96			0.98
20 (508)		0.84	0.76			1.00	0.95	0.81	0.77						1.00			1.00
22 (559)		0.87	0.79				0.99	0.84	0.79									
24 (610)		0.91	0.82				1.00	0.88	0.82									
30 (762)		1.00	0.90					0.97	0.90									
36 (914)			0.98					1.00	0.98									
>48 (1219)			1.00						1.00									

Footnotes for Tables 47 and 48

- Linear interpolation not permitted
- Shaded area with reduced edge distance is permitted provided rebar has no installation torque.
- When combining multiple load adjustment factors (e.g. for a four-anchor pattern in a corner with thin concrete member) the design can become very conservative. To optimize the design, use Hilti PROFIS Anchor Design software or perform anchor calculation using design equations from CSA A23.3-14 Annex D.
- Spacing factor reduction in shear, f_{AV} , assumes an influence of a nearby edge. If no edge exists, then $f_{AV} = f_{AN}$.
- Concrete thickness reduction factor in shear, f_{HV} , assumes an influence of a nearby edge. If no edge exists, then $f_{HV} = 1.0$.

Table 49 — Load adjustment factors for 20M rebar in uncracked concrete^{1,2,3}

20 M Uncracked Concrete	Spacing Factor in Tension f_{AN}			Edge Distance Factor in Tension f_{RN}			Spacing Factor in Shear ⁴ f_{AV}			Edge Distance in Shear						Concrete Thickness Factor in Shear ⁵ f_{HV}			
										⊥ Toward Edge f_{RV}			∥ To Edge f_{RV}						
	Embedment h_{ef} in (mm)	7-7/8 (200)	14 (355)	15-3/8 (390)	7-7/8 (200)	14 (355)	15-3/8 (390)	7-7/8 (200)	14 (355)	15-3/8 (390)	7-7/8 (200)	14 (355)	15-3/8 (390)	7-7/8 (200)	14 (355)	15-3/8 (390)	7-7/8 (200)	14 (355)	15-3/8 (390)
Spacing (s) / Edge Distance (c_e) / Concrete Thickness (h) — in (mm)	1-3/4 (44)	n/a	n/a	n/a	0.21	0.11	0.10	n/a	n/a	n/a	0.04	0.02	0.02	0.08	0.05	0.04	n/a	n/a	n/a
	3-7/8 (98)	0.58	0.55	0.54	0.28	0.15	0.14	0.54	0.53	0.53	0.14	0.08	0.07	0.27	0.15	0.14	n/a	n/a	n/a
	4 (102)	0.58	0.55	0.54	0.29	0.16	0.14	0.55	0.53	0.53	0.14	0.08	0.07	0.29	0.16	0.14	n/a	n/a	n/a
	5 (127)	0.61	0.56	0.55	0.32	0.18	0.16	0.56	0.54	0.54	0.20	0.11	0.10	0.32	0.18	0.16	n/a	n/a	n/a
	6 (152)	0.63	0.57	0.57	0.36	0.20	0.18	0.57	0.55	0.54	0.27	0.15	0.14	0.36	0.20	0.18	n/a	n/a	n/a
	7 (178)	0.65	0.58	0.58	0.40	0.22	0.20	0.58	0.55	0.55	0.34	0.19	0.17	0.40	0.22	0.20	n/a	n/a	n/a
	8 (203)	0.67	0.60	0.59	0.44	0.24	0.22	0.59	0.56	0.56	0.41	0.23	0.21	0.44	0.24	0.22	n/a	n/a	n/a
	9 (229)	0.69	0.61	0.60	0.50	0.27	0.25	0.60	0.57	0.57	0.49	0.28	0.25	0.50	0.27	0.25	n/a	n/a	n/a
	10 (254)	0.71	0.62	0.61	0.55	0.30	0.27	0.61	0.58	0.57	0.57	0.32	0.29	0.55	0.30	0.27	0.68	n/a	n/a
	11 (279)	0.73	0.63	0.62	0.61	0.33	0.30	0.63	0.59	0.58	0.66	0.37	0.34	0.61	0.33	0.30	0.71	n/a	n/a
	12 (305)	0.75	0.64	0.63	0.66	0.36	0.33	0.64	0.59	0.59	0.75	0.42	0.39	0.66	0.36	0.33	0.74	n/a	n/a
	14 (356)	0.80	0.67	0.65	0.77	0.42	0.38	0.66	0.61	0.60	0.95	0.53	0.49	0.77	0.42	0.38	0.80	n/a	n/a
	16 (406)	0.84	0.69	0.67	0.88	0.48	0.44	0.68	0.63	0.62	1.00	0.65	0.59	0.88	0.48	0.44	0.86	0.71	n/a
	18 (457)	0.88	0.71	0.70	1.00	0.54	0.49	0.71	0.64	0.63		0.78	0.71	1.00	0.54	0.49	0.91	0.75	0.73
	20 (508)	0.92	0.74	0.72		0.60	0.55	0.73	0.66	0.65		0.91	0.83		0.60	0.55	0.96	0.79	0.77
	22 (559)	0.97	0.76	0.74		0.66	0.60	0.75	0.67	0.66		1.00	0.96		0.66	0.60	1.00	0.83	0.80
	24 (610)	1.00	0.79	0.76		0.72	0.66	0.78	0.69	0.68			1.00		0.72	0.66		0.87	0.84
	26 (660)		0.81	0.78		0.78	0.71	0.80	0.70	0.69					0.78	0.71		0.90	0.87
	28 (711)		0.83	0.80		0.84	0.76	0.82	0.72	0.71					0.84	0.76		0.94	0.91
30 (762)		0.86	0.83		0.90	0.82	0.84	0.74	0.72					0.90	0.82		0.97	0.94	
36 (914)		0.93	0.89		1.00	0.98	0.91	0.78	0.76					1.00	0.98		1.00	1.00	
>48 (1219)		1.00	1.00			1.00	1.00	0.88	0.85						1.00				

Table 50 — Load adjustment factors for 20M rebar in cracked concrete^{1,2,3}

20 M Cracked Concrete	Spacing Factor in Tension f_{AN}			Edge Distance Factor in Tension f_{RN}			Spacing Factor in Shear ⁴ f_{AV}			Edge Distance in Shear						Concrete Thickness Factor in Shear ⁵ f_{HV}				
										⊥ Toward Edge f_{RV}			∥ To Edge f_{RV}							
	Embedment h_{ef} in (mm)	7-7/8 (200)	14 (355)	15-3/8 (390)	7-7/8 (200)	14 (355)	15-3/8 (390)	7-7/8 (200)	14 (355)	15-3/8 (390)	7-7/8 (200)	14 (355)	15-3/8 (390)	7-7/8 (200)	14 (355)	15-3/8 (390)	7-7/8 (200)	14 (355)	15-3/8 (390)	
Spacing (s) / Edge Distance (c_e) / Concrete Thickness (h) — in (mm)	1-3/4 (44)	n/a	n/a	n/a	0.43	0.39	0.39	n/a	n/a	n/a	0.07	0.04	0.04	0.15	0.08	0.07	n/a	n/a	n/a	
	3-7/8 (98)	0.58	0.55	0.54	0.53	0.45	0.44	0.56	0.54	0.54	0.24	0.13	0.12	0.48	0.27	0.24	n/a	n/a	n/a	
	4 (102)	0.58	0.55	0.54	0.54	0.45	0.44	0.57	0.55	0.54	0.25	0.14	0.13	0.50	0.28	0.26	n/a	n/a	n/a	
	5 (127)	0.61	0.56	0.55	0.59	0.48	0.47	0.58	0.56	0.55	0.35	0.20	0.18	0.59	0.40	0.36	n/a	n/a	n/a	
	6 (152)	0.63	0.57	0.57	0.64	0.51	0.49	0.60	0.57	0.56	0.46	0.26	0.24	0.64	0.51	0.47	n/a	n/a	n/a	
	7 (178)	0.65	0.58	0.58	0.70	0.53	0.52	0.62	0.58	0.57	0.58	0.33	0.30	0.70	0.53	0.52	n/a	n/a	n/a	
	8 (203)	0.67	0.60	0.59	0.76	0.56	0.54	0.63	0.59	0.59	0.71	0.40	0.36	0.76	0.56	0.54	n/a	n/a	n/a	
	9 (229)	0.69	0.61	0.60	0.82	0.59	0.57	0.65	0.60	0.60	0.85	0.48	0.43	0.82	0.59	0.57	n/a	n/a	n/a	
	10 (254)	0.71	0.62	0.61	0.88	0.62	0.60	0.67	0.61	0.61	0.99	0.56	0.51	0.88	0.62	0.60	0.81	n/a	n/a	
	11 (279)	0.73	0.63	0.62	0.95	0.65	0.62	0.68	0.62	0.62	1.00	0.65	0.59	0.95	0.65	0.62	0.85	n/a	n/a	
	12 (305)	0.75	0.64	0.63	1.00	0.69	0.65	0.70	0.64	0.63		0.74	0.67	1.00	0.69	0.65	0.89	n/a	n/a	
	14 (356)	0.80	0.67	0.65		0.75	0.71	0.73	0.66	0.65		0.93	0.84		0.75	0.71	0.96	n/a	n/a	
	16 (406)	0.84	0.69	0.67		0.82	0.77	0.77	0.68	0.67		1.00	1.00		0.82	0.77	1.00	0.85	n/a	
	18 (457)	0.88	0.71	0.70		0.89	0.83	0.80	0.70	0.69					0.89	0.83		0.90	0.87	
	20 (508)	0.92	0.74	0.72		0.96	0.90	0.83	0.73	0.71					0.96	0.90		0.95	0.92	
	22 (559)	0.97	0.76	0.74		1.00	0.96	0.86	0.75	0.73					1.00	0.96		1.00	0.97	
	24 (610)	1.00	0.79	0.76			1.00	0.90	0.77	0.76						1.00				1.00
	26 (660)		0.81	0.78				0.93	0.79	0.78										
	28 (711)		0.83	0.80				0.96	0.82	0.80										
30 (762)		0.86	0.83				1.00	0.84	0.82											
36 (914)		0.93	0.89					0.91	0.88											
>48 (1219)		1.00	1.00					1.00	1.00											

Footnotes for Tables 49 and 50

- 1 Linear interpolation not permitted
- 2 Shaded area with reduced edge distance is permitted provided rebar has no installation torque.
- 3 When combining multiple load adjustment factors (e.g. for a four-anchor pattern in a corner with thin concrete member) the design can become very conservative. To optimize the design, use Hilti PROFIS Anchor Design software or perform anchor calculation using design equations from CSA A23.3-14 Annex D.
- 4 Spacing factor reduction in shear, f_{AV} , assumes an influence of a nearby edge. If no edge exists, then $f_{AV} = f_{AN}$.
- 5 Concrete thickness reduction factor in shear, f_{HV} , assumes an influence of a nearby edge. If no edge exists, then $f_{HV} = 1.0$.



Table 51 — Load adjustment factors for 25M rebar in uncracked concrete 1,2,3

25 M Uncracked Concrete	Spacing Factor in Tension			Edge Distance Factor in Tension			Spacing Factor in Shear ⁴			Edge Distance in Shear						Concrete Thickness Factor in Shear ⁵			
	f_{AN}			f_{RN}			f_{AV}			⊥ Toward Edge f_{RV}			∥ To Edge f_{RV}			f_{HV}			
	Embedment h_{ef} in (mm)	9-1/16 (230)	15-15/16 (405)	19-13/16 (504)	9-1/16 (230)	15-15/16 (405)	19-13/16 (504)	9-1/16 (230)	15-15/16 (405)	19-13/16 (504)	9-1/16 (230)	15-15/16 (405)	19-13/16 (504)	9-1/16 (230)	15-15/16 (405)	19-13/16 (504)	9-1/16 (230)	15-15/16 (405)	19-13/16 (504)
Spacing (s) / Edge Distance (c_d) / Concrete Thickness (h) — in (mm)	1-3/4 (44)	n/a	n/a	n/a	0.22	0.12	0.10	n/a	n/a	n/a	0.03	0.02	0.01	0.06	0.03	0.03	n/a	n/a	n/a
	5 (127)	0.59	0.55	0.54	0.32	0.18	0.14	0.55	0.53	0.53	0.14	0.08	0.07	0.29	0.16	0.13	n/a	n/a	n/a
	6 (152)	0.61	0.56	0.55	0.35	0.19	0.15	0.55	0.54	0.53	0.19	0.11	0.09	0.35	0.19	0.15	n/a	n/a	n/a
	7 (178)	0.63	0.57	0.56	0.39	0.21	0.17	0.56	0.54	0.54	0.24	0.13	0.11	0.39	0.21	0.17	n/a	n/a	n/a
	8 (203)	0.65	0.58	0.57	0.42	0.23	0.18	0.57	0.55	0.54	0.29	0.16	0.13	0.42	0.23	0.18	n/a	n/a	n/a
	9 (229)	0.67	0.59	0.58	0.46	0.25	0.20	0.58	0.56	0.55	0.35	0.20	0.16	0.46	0.25	0.20	n/a	n/a	n/a
	10 (254)	0.68	0.60	0.58	0.50	0.27	0.22	0.59	0.56	0.55	0.40	0.23	0.18	0.50	0.27	0.22	n/a	n/a	n/a
	11-9/16 (294)	0.71	0.62	0.60	0.57	0.31	0.25	0.61	0.57	0.56	0.50	0.29	0.23	0.57	0.31	0.25	0.65	n/a	n/a
	12 (305)	0.72	0.63	0.60	0.59	0.32	0.26	0.61	0.58	0.56	0.53	0.30	0.24	0.59	0.32	0.26	0.66	n/a	n/a
	14 (356)	0.76	0.65	0.62	0.69	0.38	0.30	0.63	0.59	0.58	0.67	0.38	0.31	0.69	0.38	0.30	0.71	n/a	n/a
	16 (406)	0.79	0.67	0.63	0.79	0.43	0.34	0.65	0.60	0.59	0.82	0.47	0.37	0.79	0.43	0.34	0.76	n/a	n/a
	18 (457)	0.83	0.69	0.65	0.89	0.49	0.39	0.66	0.61	0.60	0.98	0.56	0.45	0.89	0.49	0.39	0.81	n/a	n/a
	18-7/16 (469)	0.84	0.69	0.66	0.91	0.50	0.40	0.67	0.62	0.60	1.00	0.58	0.46	0.91	0.50	0.40	0.82	0.68	n/a
	20 (508)	0.87	0.71	0.67	0.99	0.54	0.43	0.68	0.63	0.61		0.65	0.52	0.99	0.54	0.43	0.85	0.71	n/a
	22-3/8 (568)	0.91	0.73	0.69	1.00	0.60	0.48	0.70	0.64	0.62		0.77	0.62	1.00	0.60	0.48	0.90	0.75	0.70
	24 (610)	0.94	0.75	0.70		0.65	0.52	0.72	0.65	0.63		0.85	0.69		0.65	0.52	0.94	0.77	0.72
	26 (660)	0.98	0.77	0.72		0.70	0.56	0.74	0.66	0.64		0.96	0.77		0.70	0.56	0.97	0.81	0.75
	28 (711)	1.00	0.79	0.74		0.76	0.60	0.76	0.68	0.65		1.00	0.87		0.76	0.60	1.00	0.84	0.78
	30 (762)		0.81	0.75		0.81	0.65	0.77	0.69	0.66			0.96		0.81	0.65		0.87	0.81
36 (914)		0.88	0.80		0.97	0.78	0.83	0.73	0.69			1.00		0.97	0.78		0.95	0.88	
>48 (1219)		1.00	0.90		1.00	1.00	0.94	0.80	0.76					1.00	1.00		1.00	1.00	

Table 52 — Load adjustment factors for 25M rebar in cracked concrete 1,2,3



25 M Cracked Concrete	Spacing Factor in Tension			Edge Distance Factor in Tension			Spacing Factor in Shear ⁴			Edge Distance in Shear						Concrete Thickness Factor in Shear ⁵			
	f_{AN}			f_{RN}			f_{AV}			⊥ Toward Edge f_{RV}			∥ To Edge f_{RV}			f_{HV}			
	Embedment h_{ef} in (mm)	9-1/16 (230)	15-15/16 (405)	19-13/16 (504)	9-1/16 (230)	15-15/16 (405)	19-13/16 (504)	9-1/16 (230)	15-15/16 (405)	19-13/16 (504)	9-1/16 (230)	15-15/16 (405)	19-13/16 (504)	9-1/16 (230)	15-15/16 (405)	19-13/16 (504)	9-1/16 (230)	15-15/16 (405)	19-13/16 (504)
Spacing (s) / Edge Distance (c_d) / Concrete Thickness (h) — in (mm)	1-3/4 (44)	n/a	n/a	n/a	0.42	0.39	0.38	n/a	n/a	n/a	0.05	0.03	0.02	0.10	0.06	0.04	n/a	n/a	n/a
	5 (127)	0.59	0.55	0.54	0.55	0.46	0.44	0.56	0.54	0.54	0.24	0.13	0.11	0.47	0.27	0.22	n/a	n/a	n/a
	6 (152)	0.61	0.56	0.55	0.60	0.48	0.46	0.58	0.55	0.55	0.31	0.18	0.14	0.60	0.35	0.28	n/a	n/a	n/a
	7 (178)	0.63	0.57	0.56	0.65	0.51	0.48	0.59	0.56	0.55	0.39	0.22	0.18	0.65	0.44	0.36	n/a	n/a	n/a
	8 (203)	0.65	0.58	0.57	0.70	0.53	0.50	0.60	0.57	0.56	0.48	0.27	0.22	0.70	0.53	0.44	n/a	n/a	n/a
	9 (229)	0.67	0.59	0.58	0.75	0.56	0.51	0.61	0.58	0.57	0.57	0.32	0.26	0.75	0.56	0.51	n/a	n/a	n/a
	10 (254)	0.68	0.60	0.58	0.80	0.59	0.53	0.63	0.59	0.58	0.67	0.38	0.30	0.80	0.59	0.53	n/a	n/a	n/a
	11-9/16 (294)	0.71	0.62	0.60	0.89	0.63	0.57	0.65	0.60	0.59	0.83	0.47	0.38	0.89	0.63	0.57	0.77	n/a	n/a
	12 (305)	0.72	0.63	0.60	0.91	0.64	0.58	0.65	0.60	0.59	0.88	0.50	0.40	0.91	0.64	0.58	0.78	n/a	n/a
	14 (356)	0.76	0.65	0.62	1.00	0.69	0.62	0.68	0.62	0.61	1.00	0.63	0.51	1.00	0.69	0.62	0.84	n/a	n/a
	16 (406)	0.79	0.67	0.63		0.75	0.66	0.70	0.64	0.62		0.77	0.62		0.75	0.66	0.90	n/a	n/a
	18 (457)	0.83	0.69	0.65		0.81	0.71	0.73	0.66	0.64		0.92	0.74		0.81	0.71	0.96	n/a	n/a
	18-7/16 (469)	0.84	0.69	0.66		0.83	0.72	0.74	0.66	0.64		0.95	0.76		0.83	0.72	0.97	0.80	n/a
	20 (508)	0.87	0.71	0.67		0.87	0.75	0.75	0.67	0.65		1.00	0.86		0.87	0.75	1.00	0.84	n/a
	22-3/8 (568)	0.91	0.73	0.69		0.95	0.81	0.78	0.70	0.67			1.00		0.95	0.81		0.88	0.82
	24 (610)	0.94	0.75	0.70		1.00	0.85	0.81	0.71	0.68					1.00	0.85		0.92	0.85
	26 (660)	0.98	0.77	0.72			0.90	0.83	0.73	0.70						0.90		0.95	0.89
	28 (711)	1.00	0.79	0.74			0.95	0.86	0.74	0.71						0.95		0.99	0.92
	30 (762)		0.81	0.75			1.00	0.88	0.76	0.73						1.00		1.00	0.95
36 (914)		0.88	0.80				0.96	0.81	0.77									1.00	
>48 (1219)		1.00	0.90				1.00	0.92	0.86										

Footnotes for Tables 51 and 52

- Linear interpolation not permitted
- Shaded area with reduced edge distance is permitted provided rebar has no installation torque.
- When combining multiple load adjustment factors (e.g. for a four-anchor pattern in a corner with thin concrete member) the design can become very conservative. To optimize the design, use Hilti PROFIS Anchor Design software or perform anchor calculation using design equations from CSA A23.3-14 Annex D.
- Spacing factor reduction in shear, f_{AV} , assumes an influence of a nearby edge. If no edge exists, then $f_{AV} = f_{AN}$.
- Concrete thickness reduction factor in shear, f_{HV} , assumes an influence of a nearby edge. If no edge exists, then $f_{HV} = 1.0$.

Table 53 – Load adjustment factors for 30M rebar in uncracked concrete ^{1,2,3}

30 M Uncracked Concrete	Spacing Factor in Tension			Edge Distance Factor in Tension			Spacing Factor in Shear ⁴			Edge Distance in Shear						Concrete Thickness Factor in Shear ⁵			
	f_{AN}			f_{RN}			f_{AV}			⊥ Toward Edge f_{RV}			∥ To Edge f_{RV}			f_{HV}			
	Embedment h_{ef} in (mm)	10-1/4 (260)	17-15/16 (455)	23-9/16 (598)	10-1/4 (260)	17-15/16 (455)	23-9/16 (598)	10-1/4 (260)	17-15/16 (455)	23-9/16 (598)	10-1/4 (260)	17-15/16 (455)	23-9/16 (598)	10-1/4 (260)	17-15/16 (455)	23-9/16 (598)	10-1/4 (260)	17-15/16 (455)	23-9/16 (598)
Spacing (s) / Edge Distance (c_e) / Concrete Thickness (h) — in (mm)	1-3/4 (44)	n/a	n/a	n/a	0.23	0.13	0.09	n/a	n/a	n/a	0.02	0.01	0.01	0.05	0.03	0.02	n/a	n/a	n/a
	5-7/8 (150)	0.60	0.55	0.54	0.34	0.19	0.14	0.55	0.53	0.53	0.14	0.08	0.06	0.29	0.16	0.12	n/a	n/a	n/a
	6 (152)	0.60	0.56	0.54	0.34	0.19	0.14	0.55	0.53	0.53	0.15	0.08	0.06	0.29	0.17	0.13	n/a	n/a	n/a
	7 (178)	0.61	0.57	0.55	0.37	0.20	0.15	0.55	0.54	0.53	0.18	0.11	0.08	0.37	0.20	0.15	n/a	n/a	n/a
	8 (203)	0.63	0.57	0.56	0.40	0.22	0.17	0.56	0.54	0.54	0.22	0.13	0.10	0.40	0.22	0.17	n/a	n/a	n/a
	9 (229)	0.65	0.58	0.56	0.43	0.24	0.18	0.57	0.55	0.54	0.27	0.15	0.12	0.43	0.24	0.18	n/a	n/a	n/a
	10 (254)	0.66	0.59	0.57	0.47	0.26	0.19	0.58	0.55	0.54	0.31	0.18	0.14	0.47	0.26	0.19	n/a	n/a	n/a
	11 (279)	0.68	0.60	0.58	0.50	0.28	0.21	0.58	0.56	0.55	0.36	0.21	0.16	0.50	0.28	0.21	n/a	n/a	n/a
	12 (305)	0.70	0.61	0.58	0.54	0.29	0.22	0.59	0.56	0.55	0.41	0.24	0.18	0.54	0.29	0.22	n/a	n/a	n/a
	13-1/4 (337)	0.72	0.62	0.59	0.59	0.33	0.24	0.60	0.57	0.56	0.48	0.27	0.21	0.59	0.33	0.24	0.64	n/a	n/a
	14 (356)	0.73	0.63	0.60	0.63	0.34	0.26	0.61	0.57	0.56	0.52	0.30	0.23	0.63	0.34	0.26	0.66	n/a	n/a
	16 (406)	0.76	0.65	0.61	0.71	0.39	0.30	0.62	0.58	0.57	0.64	0.36	0.28	0.71	0.39	0.30	0.70	n/a	n/a
	18 (457)	0.79	0.67	0.63	0.80	0.44	0.33	0.64	0.60	0.58	0.76	0.43	0.33	0.80	0.44	0.33	0.74	n/a	n/a
	20 (508)	0.83	0.69	0.64	0.89	0.49	0.37	0.65	0.61	0.59	0.89	0.51	0.39	0.89	0.49	0.37	0.79	n/a	n/a
	20-7/8 (531)	0.84	0.69	0.65	0.93	0.51	0.39	0.66	0.61	0.59	0.95	0.54	0.41	0.93	0.51	0.39	0.80	n/a	n/a
	22 (559)	0.86	0.70	0.66	0.98	0.54	0.41	0.67	0.62	0.60	1.00	0.59	0.45	0.98	0.54	0.41	0.82	0.68	n/a
	24 (610)	0.89	0.72	0.67	1.00	0.59	0.44	0.68	0.63	0.61		0.67	0.51	1.00	0.59	0.44	0.86	0.71	n/a
	26-9/16 (675)	0.93	0.75	0.69		0.65	0.49	0.70	0.64	0.62		0.78	0.59		0.65	0.49	0.91	0.75	0.69
	28 (711)	0.96	0.76	0.70		0.69	0.52	0.72	0.65	0.62		0.84	0.64		0.69	0.52	0.93	0.77	0.70
	30 (762)	0.99	0.78	0.71		0.74	0.55	0.73	0.66	0.63		0.93	0.71		0.74	0.55	0.96	0.80	0.73
36 (914)	1.00	0.83	0.75		0.88	0.66	0.78	0.69	0.66		1.00	0.93		0.88	0.66	1.00	0.87	0.80	
>48 (1219)		0.95	0.84		1.00	0.89	0.87	0.75	0.71			1.00		1.00	0.89		1.00	0.92	

Table 54 – Load adjustment factors for 30M rebar in cracked concrete ^{1,2,3}

30 M Cracked Concrete	Spacing Factor in Tension			Edge Distance Factor in Tension			Spacing Factor in Shear ⁴			Edge Distance in Shear						Concrete Thickness Factor in Shear ⁵			
	f_{AN}			f_{RN}			f_{AV}			⊥ Toward Edge f_{RV}			∥ To Edge f_{RV}			f_{HV}			
	Embedment h_{ef} in (mm)	10-1/4 (260)	17-15/16 (455)	23-9/16 (598)	10-1/4 (260)	17-15/16 (455)	23-9/16 (598)	10-1/4 (260)	17-15/16 (455)	23-9/16 (598)	10-1/4 (260)	17-15/16 (455)	23-9/16 (598)	10-1/4 (260)	17-15/16 (455)	23-9/16 (598)	10-1/4 (260)	17-15/16 (455)	23-9/16 (598)
Spacing (s) / Edge Distance (c_e) / Concrete Thickness (h) — in (mm)	1-3/4 (44)	n/a	n/a	n/a	0.41	0.38	0.38	n/a	n/a	n/a	0.04	0.02	0.02	0.08	0.05	0.04	n/a	n/a	n/a
	5-7/8 (150)	0.60	0.55	0.54	0.56	0.47	0.44	0.57	0.55	0.54	0.26	0.15	0.11	0.52	0.30	0.22	n/a	n/a	n/a
	6 (152)	0.60	0.56	0.54	0.57	0.47	0.44	0.57	0.55	0.54	0.26	0.15	0.12	0.53	0.30	0.23	n/a	n/a	n/a
	7 (178)	0.61	0.57	0.55	0.61	0.49	0.46	0.58	0.56	0.55	0.33	0.19	0.15	0.61	0.38	0.29	n/a	n/a	n/a
	8 (203)	0.63	0.57	0.56	0.65	0.51	0.47	0.59	0.56	0.55	0.41	0.23	0.18	0.65	0.47	0.35	n/a	n/a	n/a
	9 (229)	0.65	0.58	0.56	0.69	0.53	0.49	0.60	0.57	0.56	0.49	0.28	0.21	0.69	0.53	0.42	n/a	n/a	n/a
	10 (254)	0.66	0.59	0.57	0.74	0.56	0.50	0.61	0.58	0.57	0.57	0.33	0.25	0.74	0.56	0.50	n/a	n/a	n/a
	11 (279)	0.68	0.60	0.58	0.79	0.58	0.52	0.63	0.59	0.57	0.66	0.38	0.29	0.79	0.58	0.52	n/a	n/a	n/a
	12 (305)	0.70	0.61	0.58	0.83	0.60	0.54	0.64	0.59	0.58	0.75	0.43	0.33	0.83	0.60	0.54	n/a	n/a	n/a
	13-1/4 (337)	0.72	0.62	0.59	0.89	0.63	0.56	0.65	0.60	0.59	0.87	0.50	0.38	0.89	0.63	0.56	0.78	n/a	n/a
	14 (356)	0.73	0.63	0.60	0.93	0.65	0.57	0.66	0.61	0.59	0.94	0.54	0.41	0.93	0.65	0.57	0.80	n/a	n/a
	16 (406)	0.76	0.65	0.61	1.00	0.70	0.61	0.68	0.63	0.61	1.00	0.66	0.50	1.00	0.70	0.61	0.86	n/a	n/a
	18 (457)	0.79	0.67	0.63		0.75	0.64	0.71	0.64	0.62		0.79	0.60		0.75	0.64	0.91	n/a	n/a
	20 (508)	0.83	0.69	0.64		0.81	0.68	0.73	0.66	0.63		0.92	0.70		0.81	0.68	0.96	n/a	n/a
	20-7/8 (531)	0.84	0.69	0.65		0.83	0.70	0.74	0.66	0.64		0.98	0.75		0.83	0.70	0.98	n/a	n/a
	22 (559)	0.86	0.70	0.66		0.86	0.72	0.75	0.67	0.64		1.00	0.81		0.86	0.72	1.00	0.83	n/a
	24 (610)	0.89	0.72	0.67		0.92	0.76	0.77	0.69	0.66			0.92		0.92	0.76		0.87	n/a
	26-9/16 (675)	0.93	0.75	0.69		0.99	0.81	0.80	0.71	0.67			1.00		0.99	0.81		0.92	0.84
	28 (711)	0.96	0.76	0.70		1.00	0.84	0.82	0.72	0.68					1.00	0.84		0.94	0.86
	30 (762)	0.99	0.78	0.71			0.88	0.84	0.74	0.70						0.88		0.97	0.89
36 (914)	1.00	0.83	0.75			1.00	0.91	0.78	0.74						1.00		1.00	0.97	
>48 (1219)		0.95	0.84				1.00	0.88	0.82									1.00	

Footnotes for Tables 53 and 54

- Linear interpolation not permitted.
- Shaded area with reduced edge distance is permitted provided rebar has no installation torque.
- When combining multiple load adjustment factors (e.g. for a four-anchor pattern in a corner with thin concrete member) the design can become very conservative. To optimize the design, use Hilti PROFIS Anchor Design software or perform anchor calculation using design equations from CSA A23.3 Annex D.
- Spacing factor reduction in shear, f_{AV} , assumes an influence of a nearby edge. If no edge exists, then $f_{AV} = f_{AN}$.
- Concrete thickness reduction factor in shear, f_{HV} , assumes an influence of a nearby edge. If no edge exists, then $f_{HV} = 1.0$.



Table 55 — Hilti HIT-RE 100 design information with HAS threaded rods in hammer drilled holes in accordance with CSA A23.3-14 Annex D ^{1,9}

Design parameter	Symbol	Units	Nominal rod diameter (in.)							Ref A23.3-14	
			3/8	1/2	5/8	3/4	7/8	1	1-1/4		
Anchor O.D.	d_a	mm	9.5	12.7	15.9	19.1	22.2	25.4	31.8		
Effective minimum embedment ²	h_{ef}	mm	60	70	79	89	89	102	127		
Effective maximum embedment ²	h_{ef}	mm	191	254	318	381	445	508	635		
Minimum concrete thickness ²	h_{min}	mm	$h_{ef} + 30$		$h_{ef} + 2d_o$						
Critical edge distance	c_{ac}	mm	See ESR-3829, section 4.1.10								
Minimum edge distance	c_{min}^3	mm	48	64	79	95	111	127	159		
Minimum anchor spacing	s_{min}	mm	48	64	79	95	111	127	159		
Coeff. for factored conc. breakout resistance, uncracked concrete	$k_{c,uncr}^4$	-	10							D.6.2.2	
Coeff. for factored conc. breakout resistance, cracked concrete	$k_{c,cr}^4$	-	7							D.6.2.2	
Concrete material resistance factor	ϕ_c	-	0.65							8.4.2	
Resistance modification factor for tension and shear, concrete failure modes, Condition B ⁵	R_{conc}	-	1.00							D.5.3 (c)	
Dry Concrete											
Temp. range A ⁶	Characteristic bond stress in cracked concrete ^{7,8}	T_{cr}	psi (MPa)	616 (4.2)	592 (4.1)	592 (4.1)	560 (3.9)	516 (3.6)	480 (3.3)	408 (2.8)	D.6.5.2
	Characteristic bond stress in uncracked concrete ^{7,8}	T_{uncr}	psi (MPa)	1,272 (8.8)	1,256 (8.7)	1,204 (8.3)	1,164 (8.0)	1,124 (7.8)	1,092 (7.5)	1,048 (7.2)	D.6.5.2
Anchor category, dry concrete		-	-	2	2	2	2	2	2	2	
Resistance modification factor		R_{dry}	-	0.85	0.85	0.85	0.85	0.85	0.85	0.85	
Water Saturated Concrete											
Temp. range A ⁶	Characteristic bond stress in cracked concrete ^{7,8}	T_{cr}	psi (MPa)	548 (3.8)	521 (3.6)	521 (3.6)	476 (3.3)	416 (2.9)	375 (2.6)	300 (2.1)	D.6.5.2
	Characteristic bond stress in uncracked concrete ^{7,8}	T_{uncr}	psi (MPa)	1,133 (7.8)	1,106 (7.6)	1,061 (7.3)	994 (6.9)	915 (6.3)	859 (5.9)	776 (5.4)	D.6.5.2
Anchor category, water-saturated concrete		-	-	2	2	2	2	2	2	2	
Resistance modification factor		R_{ws}	-	0.85	0.85	0.85	0.85	0.85	0.85	0.85	
Water-Filled Hole											
Temp. range A ⁶	Characteristic bond stress in cracked concrete ^{7,8}	T_{cr}	psi (MPa)	548 (3.8)	521 (3.6)	521 (3.6)	476 (3.3)	416 (2.9)	375 (2.6)	300 (2.1)	D.6.5.2
	Characteristic bond stress in uncracked concrete ^{7,8}	T_{uncr}	psi (MPa)	1,133 (7.8)	1,106 (7.6)	1,061 (7.3)	994 (6.9)	915 (6.3)	859 (5.9)	776 (5.4)	D.6.5.2
Anchor category, water-filled hole		-	-	3	3	3	3	3	3	3	D.5.3 (c)
Resistance modification factor		R_{wf}	-	0.75	0.75	0.75	0.75	0.75	0.75	0.75	
Underwater Application											
Temp. range A ⁶	Characteristic bond stress in cracked concrete ^{7,8}	T_{cr}	psi (MPa)	548 (3.8)	521 (3.6)	521 (3.6)	476 (3.3)	416 (2.9)	375 (2.6)	300 (2.1)	D.6.5.2
	Characteristic bond stress in uncracked concrete ^{7,8}	T_{uncr}	psi (MPa)	1,133 (7.8)	1,106 (7.6)	1,061 (7.3)	994 (6.9)	915 (6.3)	859 (5.9)	776 (5.4)	D.6.5.2
Anchor category, underwater		-	-	3	3	3	3	3	3	3	
Resistance modification factor		R_{uw}	-	0.75	0.75	0.75	0.75	0.75	0.75	0.75	

Figure 4 — HAS threaded rods

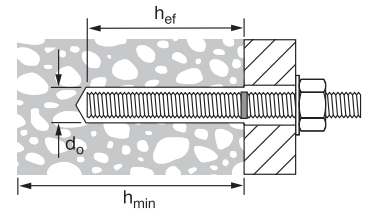

1 Design information in this table is taken from ICC-ES ESR-3829, dated September, 2019, table 8 and 9, and converted for use with CSA A23.3-14 Annex D.
 2 See figure 4.
 3 Minimum edge distance may be reduced to $45\text{mm} < c_{ai} < 5d$ provided T_{inst} is reduced per ESR-3829 section 4.1.9. See ESR-3829 section 4.1.9.
 4 For all design cases, $\psi_{c,N} = 1.0$. The appropriate coefficient for breakout resistance for cracked concrete ($k_{c,cr}$) or uncracked concrete ($k_{c,uncr}$) must be used.
 5 For use with the load combinations of CSA A23.3-14 chapter 8. Condition B applies where supplementary reinforcement in conformance with CSA A23.3-14 section D.5.3 is not provided, or where pullout or pryout strength governs. For cases where the presence of supplementary reinforcement can be verified, the resistance modification factors associated with Condition A may be used.
 6 Temperature range A: Max. short term temperature = 130°F (55°C), max. long term temperature = 110°F (43°C). Short term elevated concrete temperatures are those that occur over brief intervals, e.g., as a result of diurnal cycling. Long term concrete temperatures are roughly constant over significant periods of time.
 7 Bond strength values corresponding to concrete compressive strength $f'_c = 2,500$ psi (17.2 MPa). For concrete compressive strength, f'_c , between 2,500 psi (17.2 MPa) and 8,000 psi (55.2 MPa), the tabulated characteristic bond strength may be increased by a factor of $(f'_c/2,500)^{0.1}$ [for SI: $(f'_c/17.2)^{0.1}$].
 8 Bond strength values are for sustained loads including dead and live loads. For load combinations consisting of short-term loads only such as wind and seismic, bond strengths may be increased by 40 percent.
 9 For structures assigned to Seismic Design Categories C, D, E, or F, bond strength values must be multiplied by $\alpha_{N,seis} = 0.9$.

Table 56 — Hilti HIT-RE 100 adhesive factored resistance with concrete / bond failure for threaded rod in uncracked concrete ^{1,2,3,4,5,6,7,8,9,10}

Nominal Anchor Diameter in. (mm)	Effective embedment depth in. (mm)	Tension — N_n				Shear — V_n			
		$f'_c = 20$ MPa (2,900 psi) lb (kN)	$f'_c = 25$ MPa (3,625 psi) lb (kN)	$f'_c = 30$ MPa (4,350 psi) lb (kN)	$f'_c = 40$ MPa (5,800 psi) lb (kN)	$f'_c = 20$ MPa (2,900 psi) lb (kN)	$f'_c = 25$ MPa (3,625 psi) lb (kN)	$f'_c = 30$ MPa (4,350 psi) lb (kN)	$f'_c = 40$ MPa (5,800 psi) lb (kN)
3/8	2-3/8 (60)	1,995 (8.9)	2,040 (9.1)	2,080 (9.2)	2,140 (9.5)	1,995 (8.9)	2,040 (9.1)	2,080 (9.2)	2,140 (9.5)
	3-3/8 (86)	2,840 (12.6)	2,900 (12.9)	2,955 (13.1)	3,040 (13.5)	5,675 (25.2)	5,805 (25.8)	5,910 (26.3)	6,080 (27.1)
	4-1/2 (114)	3,785 (16.8)	3,870 (17.2)	3,940 (17.5)	4,055 (18.0)	7,565 (33.7)	7,735 (34.4)	7,880 (35.1)	8,110 (36.1)
	7-1/2 (191)	6,305 (28.0)	6,450 (28.7)	6,565 (29.2)	6,760 (30.1)	12,610 (56.1)	12,895 (57.4)	13,135 (58.4)	13,515 (60.1)
1/2	2-3/4 (70)	3,045 (13.5)	3,115 (13.8)	3,170 (14.1)	3,260 (14.5)	6,090 (27.1)	6,225 (27.7)	6,340 (28.2)	6,525 (29.0)
	4-1/2 (114)	4,980 (22.2)	5,095 (22.7)	5,185 (23.1)	5,340 (23.1)	9,960 (44.3)	10,185 (45.3)	10,375 (46.1)	10,675 (47.5)
	6 (152)	6,640 (29.5)	6,790 (30.2)	6,915 (30.8)	7,120 (31.7)	13,285 (59.1)	13,580 (60.4)	13,830 (61.5)	14,235 (63.3)
	10 (254)	11,070 (49.2)	11,320 (50.3)	11,525 (51.3)	11,865 (52.8)	22,140 (98.5)	22,635 (100.7)	23,055 (102.5)	23,725 (105.5)
5/8	3-1/8 (79)	4,145 (18.4)	4,240 (18.9)	4,315 (19.2)	4,440 (19.8)	8,290 (36.9)	8,475 (37.7)	8,635 (38.4)	8,885 (39.5)
	5-5/8 (143)	7,460 (33.2)	7,630 (33.9)	7,770 (34.6)	7,995 (35.6)	14,920 (66.4)	15,260 (67.9)	15,540 (69.1)	15,990 (71.1)
	7-1/2 (191)	9,950 (44.2)	10,170 (45.2)	10,360 (46.1)	10,660 (47.4)	19,895 (88.5)	20,345 (90.5)	20,720 (92.2)	21,325 (94.8)
	12-1/2 (318)	16,580 (73.7)	16,955 (75.4)	17,265 (76.8)	17,770 (79.0)	33,160 (147.5)	33,905 (150.8)	34,530 (153.6)	35,540 (158.1)
3/4	3-1/2 (89)	5,385 (24.0)	5,505 (24.5)	5,610 (24.9)	5,770 (25.7)	10,770 (47.9)	11,015 (49.0)	11,215 (49.9)	11,545 (51.4)
	6-3/4 (171)	10,385 (46.2)	10,620 (47.2)	10,815 (48.1)	11,130 (49.5)	20,775 (92.4)	21,240 (94.5)	21,630 (96.2)	22,265 (99.0)
	9 (229)	13,850 (61.6)	14,160 (63.0)	14,420 (64.2)	14,845 (66.0)	27,695 (123.2)	28,320 (126.0)	28,845 (128.3)	29,685 (132.0)
	15 (381)	23,080 (102.7)	23,600 (105.0)	24,035 (106.9)	24,740 (110.0)	46,160 (205.3)	47,205 (210.0)	48,070 (213.8)	49,475 (220.1)
7/8	3-1/2 (89)	5,480 (24.4)	6,125 (27.2)	6,320 (28.1)	6,505 (28.9)	10,955 (48.7)	12,250 (54.5)	12,635 (56.2)	13,005 (57.9)
	7-7/8 (200)	13,650 (60.7)	13,960 (62.1)	14,215 (63.2)	14,630 (65.1)	27,300 (121.4)	27,920 (124.2)	28,430 (126.5)	29,260 (130.2)
	10-1/2 (267)	18,200 (81.0)	18,610 (82.8)	18,955 (84.3)	19,510 (86.8)	36,405 (161.9)	37,225 (165.6)	37,910 (168.6)	39,015 (173.6)
	17-1/2 (445)	30,335 (134.9)	31,020 (138.0)	31,590 (140.5)	32,515 (144.6)	60,670 (269.9)	62,040 (276.0)	63,185 (281.0)	65,025 (289.3)
1	4 (102)	6,690 (29.8)	7,480 (33.3)	8,020 (35.7)	8,250 (36.7)	13,385 (59.5)	14,965 (66.6)	16,035 (71.3)	16,505 (73.4)
	9 (229)	17,325 (77.1)	17,715 (78.8)	18,040 (80.2)	18,565 (82.6)	34,645 (154.1)	35,425 (157.6)	36,080 (160.5)	37,130 (165.2)
	12 (305)	23,095 (102.7)	23,620 (105.1)	24,055 (107.0)	24,755 (110.1)	46,195 (205.5)	47,235 (210.1)	48,105 (214.0)	49,510 (220.2)
	20 (508)	38,495 (171.2)	39,365 (175.1)	40,090 (178.3)	41,260 (183.5)	76,990 (342.5)	78,725 (350.2)	80,175 (356.6)	82,515 (367.0)
1-1/4	5 (127)	9,355 (41.6)	10,455 (46.5)	11,455 (51.0)	12,375 (55.0)	18,705 (83.2)	20,915 (93.0)	22,910 (101.9)	24,745 (110.1)
	11-1/4 (286)	25,975 (115.5)	26,560 (118.2)	27,050 (120.3)	27,840 (123.8)	51,950 (231.1)	53,125 (236.3)	54,100 (240.7)	55,680 (247.7)
	15 (381)	34,635 (154.1)	35,415 (157.5)	36,070 (160.4)	37,120 (165.1)	69,270 (308.1)	70,830 (315.1)	72,135 (320.9)	74,240 (330.2)
	25 (635)	57,725 (256.8)	59,025 (262.6)	60,115 (267.4)	61,865 (275.2)	115,450 (513.5)	118,055 (525.1)	120,225 (534.8)	123,735 (550.4)

1 See Section 3.1.8 (2019 PTG) for explanation on development of load values.
2 See Section 3.1.8.6 (2019 PTG) to convert design strength value to ASD value.
3 Linear interpolation between embedment depths and concrete compressive strengths is not permitted.
4 Apply spacing, edge distance, and concrete thickness factors in tables 26 - 39 as necessary. Compare to the steel values in table 25. The lesser of the values is to be used for the design.
5 Values are for the following temperature range: maximum short term temperature = 130°F (55°C), maximum long term temperature = 110°F (43°C). Short term elevated concrete temperatures are those that occur over brief intervals, e.g., as a result of diurnal cycling. Long term concrete temperatures are roughly constant over significant periods of time.
6 Tabular values are for dry concrete conditions. For water saturated concrete, water-filled drilled holes, or submerged (underwater) applications multiply design strength by 0.61.
7 Tabular values are for short term loads only. For sustained loads including overhead use, see Section 3.1.8.8 (2019 PTG).
8 Tabular values are for normal-weight concrete only. For lightweight concrete multiply design strength by λ_n as follows:
For sand-lightweight, $\lambda_n = 0.51$. For all-lightweight, $\lambda_n = 0.45$.
9 Tabular values are for holes drilled in concrete with carbide tipped hammer drill bit. Diamond core drilling is not permitted.
10 Tabular values are for static loads only. Seismic design is not permitted for uncracked concrete.



Table 57 — Hilti HIT-RE 100 adhesive factored resistance with concrete / bond failure for threaded rod in cracked concrete ^{1,2,3,4,5,6,7,8,9,10}

Nominal Anchor Diameter in. (mm)	Effective embedment depth in. (mm)	Tension — N_n				Shear — V_n			
		$f'_c = 20$ MPa (2,900 psi) lb (kN)	$f'_c = 25$ MPa (3,625 psi) lb (kN)	$f'_c = 30$ MPa (4,350 psi) lb (kN)	$f'_c = 40$ MPa (5,800 psi) lb (kN)	$f'_c = 20$ MPa (2,900 psi) lb (kN)	$f'_c = 25$ MPa (3,625 psi) lb (kN)	$f'_c = 30$ MPa (4,350 psi) lb (kN)	$f'_c = 40$ MPa (5,800 psi) lb (kN)
3/8	2-3/8 (60)	965 (4.3)	990 (4.4)	1,005 (4.5)	1,035 (4.6)	965 (4.3)	990 (4.4)	1,005 (4.5)	1,035 (4.6)
	3-3/8 (86)	1,375 (6.1)	1,405 (6.3)	1,430 (6.4)	1,475 (6.6)	2,750 (12.2)	2,810 (12.5)	2,860 (12.7)	2,945 (13.1)
	4-1/2 (114)	1,830 (8.1)	1,875 (8.3)	1,910 (8.5)	1,965 (8.7)	3,665 (16.3)	3,745 (16.7)	3,815 (17.0)	3,925 (17.5)
	7-1/2 (191)	3,055 (13.6)	3,125 (13.9)	3,180 (14.1)	3,275 (14.6)	6,105 (27.2)	6,245 (27.8)	6,360 (28.3)	6,545 (29.1)
1/2	2-3/4 (70)	1,435 (6.4)	1,465 (6.5)	1,495 (6.6)	1,540 (6.8)	2,870 (12.8)	2,935 (13.1)	2,990 (13.3)	3,075 (13.7)
	4-1/2 (114)	2,350 (10.4)	2,400 (10.7)	2,445 (10.9)	2,515 (11.2)	4,695 (20.9)	4,800 (21.4)	4,890 (21.8)	5,035 (22.4)
	6 (152)	3,130 (13.9)	3,200 (14.2)	3,260 (14.5)	3,355 (14.9)	6,260 (27.8)	6,400 (28.5)	6,520 (29.0)	6,710 (29.8)
	10 (254)	5,215 (23.2)	5,335 (23.7)	5,435 (24.2)	5,590 (24.9)	10,435 (46.4)	10,670 (47.5)	10,865 (48.3)	11,185 (49.7)
5/8	3-1/8 (79)	2,040 (9.1)	2,085 (9.3)	2,120 (9.4)	2,185 (9.7)	4,075 (18.1)	4,170 (18.5)	4,245 (18.9)	4,370 (19.4)
	5-5/8 (143)	3,670 (16.3)	3,750 (16.7)	3,820 (17.0)	3,930 (17.5)	7,335 (32.6)	7,500 (33.4)	7,640 (34.0)	7,865 (35.0)
	7-1/2 (191)	4,890 (21.8)	5,000 (22.2)	5,095 (22.7)	5,240 (23.3)	9,780 (43.5)	10,005 (44.5)	10,185 (45.3)	10,485 (46.6)
	12-1/2 (318)	8,150 (36.3)	8,335 (37.1)	8,490 (37.8)	8,735 (38.9)	16,305 (72.5)	16,670 (74.2)	16,980 (75.5)	17,475 (77.7)
3/4	3-1/2 (89)	2,590 (11.5)	2,650 (11.8)	2,700 (12.0)	2,775 (12.4)	5,180 (23.1)	5,300 (23.6)	5,395 (24.0)	5,555 (24.7)
	6-3/4 (171)	4,995 (22.2)	5,110 (22.7)	5,205 (23.1)	5,355 (23.8)	9,995 (44.5)	10,220 (45.5)	10,405 (46.3)	10,710 (47.6)
	9 (229)	6,665 (29.6)	6,815 (30.3)	6,940 (30.9)	7,140 (31.8)	13,325 (59.3)	13,625 (60.6)	13,875 (61.7)	14,280 (63.5)
	15 (381)	11,105 (49.4)	11,355 (50.5)	11,565 (51.4)	11,900 (52.9)	22,210 (98.8)	22,710 (101.0)	23,125 (102.9)	23,800 (105.9)
7/8	3-1/2 (89)	2,785 (12.4)	2,850 (12.7)	2,900 (12.9)	2,985 (13.3)	5,570 (24.8)	5,695 (25.3)	5,800 (25.8)	5,970 (26.6)
	7-7/8 (200)	6,265 (27.9)	6,410 (28.5)	6,525 (29.0)	6,715 (29.9)	12,535 (55.8)	12,815 (57.0)	13,055 (58.1)	13,435 (59.8)
	10-1/2 (267)	8,355 (37.2)	8,545 (38.0)	8,700 (38.7)	8,955 (39.8)	16,710 (74.3)	17,090 (76.0)	17,405 (77.4)	17,910 (79.7)
	17-1/2 (445)	13,925 (61.9)	14,240 (63.3)	14,505 (64.5)	14,925 (66.4)	27,855 (123.9)	28,480 (126.7)	29,005 (129.0)	29,850 (132.8)
1	4 (102)	3,385 (15.1)	3,460 (15.4)	3,525 (15.7)	3,625 (16.1)	6,770 (30.1)	6,920 (30.8)	7,050 (31.4)	7,255 (32.3)
	9 (229)	7,615 (33.9)	7,785 (34.6)	7,930 (35.3)	8,160 (36.3)	15,230 (67.7)	15,570 (69.3)	15,860 (70.5)	16,320 (72.6)
	12 (305)	10,150 (45.2)	10,380 (46.2)	10,575 (47.0)	10,880 (48.4)	20,305 (90.3)	20,765 (92.4)	21,145 (94.1)	21,760 (96.8)
	20 (508)	16,920 (75.3)	17,305 (77.0)	17,620 (78.4)	18,135 (80.7)	33,840 (150.5)	34,605 (153.9)	35,240 (156.8)	36,270 (161.3)
1-1/4	5 (127)	4,495 (20.0)	4,595 (20.4)	4,680 (20.8)	4,815 (21.4)	8,990 (40.0)	9,190 (40.9)	9,360 (41.6)	9,635 (42.9)
	11-1/4 (286)	10,115 (45.0)	10,340 (46.0)	10,530 (46.8)	10,840 (48.2)	20,225 (90.0)	20,680 (92.0)	21,060 (93.7)	21,675 (96.4)
	15 (381)	13,485 (60.0)	13,790 (61.3)	14,040 (62.5)	14,450 (64.3)	26,965 (120.0)	27,575 (122.7)	28,085 (124.9)	28,905 (128.6)
	25 (635)	22,475 (100.0)	22,980 (102.2)	23,405 (104.1)	24,085 (107.1)	44,945 (199.9)	45,960 (204.4)	46,805 (208.2)	48,170 (214.3)

1 See Section 3.1.8 (2019 PTG) for explanation on development of load values.
 2 See Section 3.1.8.6 (2019 PTG) to convert design strength value to ASD value.
 3 Linear interpolation between embedment depths and concrete compressive strengths is not permitted.
 4 Apply spacing, edge distance, and concrete thickness factors in tables 26 - 39 as necessary. Compare to the steel values in table 25. The lesser of the values is to be used for the design.
 5 Values are for the following temperature range: maximum short term temperature = 130°F (55°C), maximum long term temperature = 110°F (43°C). Short term elevated concrete temperatures are those that occur over brief intervals, e.g., as a result of diurnal cycling. Long term concrete temperatures are roughly constant over significant periods of time.
 6 Tabular values are for dry concrete conditions. For water saturated concrete, water-filled drilled holes, or submerged (underwater) applications multiply design strength by 0.61.
 7 Tabular values are for short term loads only. For sustained loads including overhead use, see Section 3.1.8.8 (2019 PTG)
 8 Tabular values are for normal-weight concrete only. For lightweight concrete multiply design strength by λ_n as follows:
 For sand-lightweight, $\lambda_n = 0.51$. For all-lightweight, $\lambda_n = 0.45$.
 9 Tabular values are for holes drilled in concrete with carbide tipped hammer drill bit. Diamond core drilling is not permitted.
 10 Tabular values are for static loads only. For seismic loads, multiply cracked concrete tabular values in tension and shear by $\alpha_{seis} = 0.675$. See section 3.1.8.7 (2019 PTG) for additional information on seismic applications.

POST-INSTALLED REBAR DESIGN IN CONCRETE PER ACI 318



Development and splicing of post-installed reinforcement

Calculations for post-installed rebar for typical development lengths may be done according to ACI 318-14 Chapter 25 (formerly ACI 318-11 Chapter 12) and CSA A23.3-14 Chapter 12 for adhesive anchors tested and approved in accordance with AC 308.

This section contains tables for the data provided in ICC Evaluation Services ESR-3829. Refer to section 3.1.14 (2019 PTG) and the Hilti North America Post-Installed Reinforcing Bar Guide for the design method.

Table 58 — Calculated tension development and Class B splice lengths for Grade 60 bars in walls, slabs, columns, and footings per ACI 318-11 Chapter 12^{3,4,5,6,7,8}

Rebar size	$\frac{c_b + K_{tr}}{d_b}$	Min. edge dist. in. ¹	Min. spacing in. ²	f' _c = 2500 psi		f' _c = 3000 psi		f' _c = 4000 psi		f' _c = 6000 psi	
				ℓ _d in.	Class B splice in.	ℓ _d in.	Class B splice in.	ℓ _d in.	Class B splice in.	ℓ _d in.	Class B splice in.
#3	2.5	2-1/4	2	12	14	12	13	12	12	12	12
#4		2-3/4	2-1/2	14	19	13	17	12	15	12	12
#5		3	3-1/4	18	23	16	21	14	18	12	15
#6		3-3/4	3-3/4	22	28	20	26	17	22	14	18
#7		4-1/2	4-1/2	32	41	29	37	25	32	20	26
#8		5	5	36	47	33	43	28	37	23	30
#9		5-1/4	5-3/4	41	53	37	48	32	42	26	34
#10		5-3/4	6-1/2	46	59	42	54	36	47	30	38

- 1 Edge distances are determined using the minimum cover specified by ESR-3829 with an additional 6% of the development length per suggestions for drilling without an aid per Hilti Post-Installed Reinforcing Bar Guide Section 3.3. Smaller edge distances may be possible, for which development and splice lengths may need to be recalculated. For further information on required cover see ACI 318-14, Sec. 20.6.1.3; see Sec. 2.2 for determination of c_b.
- 2 Spacing values represent those producing c_b = 5 d_b rounded up to the nearest 1/4 in. Smaller spacing values may be possible, for which development and splice lengths may need to be recalculated. For further information on required spacing see ACI 318-14 Sec. 25.2; see Sec. 2.2 for determination of c_b.
- 3 ψ_s = 1.0 See ACI 318-14, Sec. 25.4.2.4.
- 4 ψ_s = 1.0 for non-epoxy coated bars. See ACI 318-14, Sec. 25.4.2.4.
- 5 ψ_s = 0.8 for #6 bars and smaller bars, 1.0 for #7 and larger bars. See ACI 318-14, Sec. 25.4.2.4.
- 6 Values are for normal weight concrete. For sand-lightweight concrete, multiply development and splice lengths by 1.18, for all-lightweight concrete multiply development and splice lengths by 1.33. See ACI 318-14 Sec. 19.2.4.
- 7 Development and splice length values are for static design. Seismic design development and splice lengths can be found in ACI 318-14 18.8.5 for special moment frames and ACI 318-14 18.10.2.3 for special structural walls. For further information about reinforcement in seismic design, see ACI 318-14 Ch. 18.
- 8 Refer to the Hilti North America Post-Installed Reinforcing Bar Guide for further explanation, background information, and design examples.

Table 59 – Suggested embedment, edge distance, and spacing (see Figure 5) to develop 125% of f_y in Grade 60 bars based on ACI 318-11 Appendix D – SDC A and B only^{1,2,3,4,5}

Rebar size	$f'_c = 2500$ psi				$f'_c = 3000$ psi				$f'_c = 4000$ psi				$f'_c = 6000$ psi			
	Effect. embed. h_{ef} in.	Minimum edge dist. $c_{a,min}$ in.		Min. spacing s_{min} in.	Effect. embed. h_{ef} in.	Minimum edge dist. $c_{a,min}$ in.		Min. spacing s_{min} in.	Effect. embed. h_{ef} in.	Minimum edge dist. $c_{a,min}$ in.		Min. spacing s_{min} in.	Effect. embed. h_{ef} in.	Minimum edge dist. $c_{a,min}$ in.		Min. spacing s_{min} in.
		Cond. I	Cond. II			Cond. I	Cond. II			Cond. I	Cond. II			Cond. I	Cond. II	
#3	7	18	8	15	7	18	7	14	7	17	7	13	7	17	6	11
#4	10	25	11	22	10	25	11	21	9	24	10	19	9	24	9	17
#5	13	32	15	29	12	31	14	28	12	31	13	25	12	30	11	22
#6	15	38	19	37	15	38	18	35	15	37	16	32	14	36	14	28
#7	22	54	23	45	21	53	22	43	21	53	20	39	20	51	17	34
#8	26	63	27	54	25	63	26	51	24	62	23	47	24	60	21	41
#9	29	72	32	63	29	71	30	60	28	70	27	54	27	68	24	48
#10	34	82	37	74	33	81	35	70	32	80	32	64	31	78	28	56

- 1 Additional reductions per ACI 318-11 D.4.1.2 are not included, however, and as such these embedments are not intended for sustained tension load applications. Shaded embedment values exceed 20 bar diameters. The particular assumptions used for the application of anchor theory to bar development (e.g., bar yield and bond strength values) are a matter of engineering judgment and will in part depend on the specific circumstances of the design. For embedments corresponding to nominal yield (i.e., no overstrength) multiply the unbolded and bolded tabulated h_{ef} values by 0.80 and 0.86, respectively.
- 2 c_a and s are the minimum edge distance and bar spacing (from bar centerline) associated with the tabulated embedments.
- 3 Applicable for hammer-drilled holes.
- 4 Values are for normal weight concrete. For lightweight concrete contact Hilti.
- 5 Refer to the Hilti North America Post-Installed Reinforcing Bar Guide for further explanation, background information, and design examples. See Hilti Instructions for Use (IFU) for specific installation requirements.

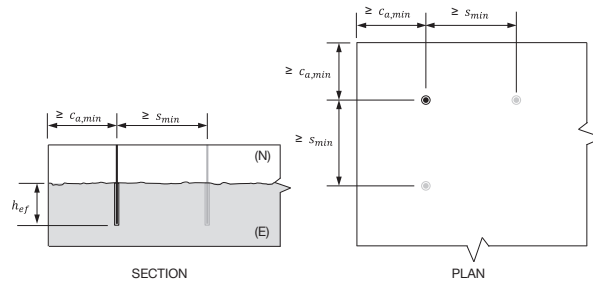

Figure 5 – Illustration of Table 59 dimensions

Table 60 — Suggested embedment, edge distance, and spacing (see Figure 6) to develop 125% of f_y in Canadian 400 MPa bars based on CSA A23.3-14 Annex D — non-seismic design only^{1,2,3,4,5}



Rebar size	$f'_c = 20 \text{ MPa}$				$f'_c = 25 \text{ MPa}$				$f'_c = 30 \text{ MPa}$				$f'_c = 40 \text{ MPa}$			
	Effective embedment h_{ef} mm	Minimum edge dist. $c_{a,min}$ mm		Minimum spacing s_{min} mm	Effective embedment h_{ef} mm	Minimum edge dist. $c_{a,min}$ mm		Minimum spacing s_{min} mm	Effective embedment h_{ef} mm	Minimum edge dist. $c_{a,min}$ mm		Minimum spacing s_{min} mm	Effective embedment h_{ef} mm	Minimum edge dist. $c_{a,min}$ mm		Minimum spacing s_{min} mm
		Cond. I	Cond. II			Cond. I	Cond. II			Cond. I	Cond. II			Cond. I	Cond. II	
10M	200	510	220	440	200	510	200	400	190	500	190	380	190	490	180	350
15M	300	760	350	690	290	750	320	640	280	740	300	600	280	730	280	550
20M	380	950	450	900	370	940	420	840	360	930	400	790	350	910	360	720
25M	600	1,510	630	1,260	590	1,480	590	1,170	580	1,470	560	1,110	560	1,440	500	1,000
30M	740	1,830	790	1,580	720	1,800	740	1,470	710	1,780	690	1,380	690	1,750	630	1,260

1 Additional reductions per ACI 318-11 D.4.1.2 are not included, however, and as such these embedments are not intended for sustained tension load applications. Shaded embedment values exceed 20 bar diameters. The particular assumptions used for the application of anchor theory to bar development (e.g., bar yield and bond strength values) are a matter of engineering judgment and will in part depend on the specific circumstances of the design. For embedments corresponding to nominal yield (i.e., no overstrength) multiply the unbolded and bolded tabulated h_{ef} values by 0.80 and 0.86, respectively.

2 c_a and s are the minimum edge distance and bar spacing (from bar centerline) associated with the tabulated embedments.

3 Applicable for hammer-drilled holes.

4 Values are for normal weight concrete. For lightweight concrete contact Hilti.

5 Refer to the Hilti North America Post-Installed Reinforcing Bar Guide for further explanation, background information, and design examples. See Hilti Instructions for Use (IFU) for specific installation requirements.

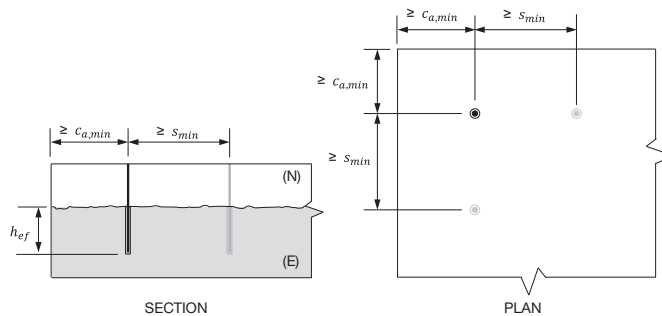

Figure 6 — Illustration of Table 60 dimensions

Table 61 — Suggested embedment and edge distance (see Figure 7) based on ACI 318-11 Appendix D to develop 125% of f_y in Grade 60 wall/column starter bars in a linear array with bar spacing = 24 inches —^ySDC A and B only^{1,2,3,4,5}

Rebar size	Linear spacing s in.	$f'_c = 2500$ psi			$f'_c = 3000$ psi			$f'_c = 4000$ psi			$f'_c = 6000$ psi		
		Effective embedment h_{ef} in.	Minimum edge dist. $c_{a,min}$ in.		Effective embedment h_{ef} in.	Minimum edge dist. $c_{a,min}$ in.		Effective embedment h_{ef} in.	Minimum edge dist. $c_{a,min}$ in.		Effective embedment h_{ef} in.	Minimum edge dist. $c_{a,min}$ in.	
			Cond. I	Cond. II		Cond. I	Cond. II		Cond. I	Cond. II		Cond. I	Cond. II
#3	24	5	14	8	5	14	7	5	14	7	5	14	6
#4		8	22	11	7	20	11	7	19	10	7	19	9
#5		13	37	19	11	32	17	9	26	13	8	24	11
#6		21	62	32	19	54	28	15	45	23	11	33	17
#7		32	91	47	28	82	42	23	68	35	18	52	26

1 Shaded embedment values exceed 20 bar diameters. For non-tabulated rebar sizes, design per development length provisions is recommended. The particular assumptions used for the application of anchor theory to bar development (e.g., bar yield and bond strength values) are a matter of engineering judgment and will in part depend on the specific circumstances of the design. For embedments corresponding to nominal yield (i.e., no overstrength) multiply the tabulated h_{ef} values by 0.86.

2 c_a is the minimum edge distance (from bar centerline) associated with the tabulated embedments and $s = 24$ in.

3 Applicable for hammer-drilled holes.

4 Values are for normal weight concrete. For lightweight concrete contact Hilti.

5 Refer to the Hilti North America Post-Installed Reinforcing Bar Guide for detailed explanation, background information, and design examples. See Hilti Instructions for Use (IFU) for specific installation requirements.

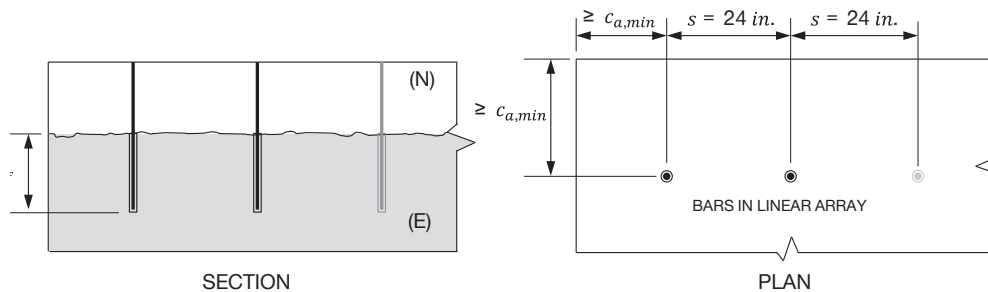

Figure 7 — Illustration of Table 61 dimensions

Table 62 — Suggested embedment and edge distance (see Figure 8) based on ACI 318-11 Appendix D to develop 125% of f_y in Grade 60 wall/column starter bars in a linear array with bar spacing = 18 inches — SDC A and B only^{1,2,3,4,5}

Rebar size	Linear spacing s in.	$f'_c = 2500$ psi			$f'_c = 3000$ psi			$f'_c = 4000$ psi			$f'_c = 6000$ psi		
		Effective embedment h_{ef} in.	Minimum edge dist. $c_{a,min}$ in.		Effective embedment h_{ef} in.	Minimum edge dist. $c_{a,min}$ in.		Effective embedment h_{ef} in.	Minimum edge dist. $c_{a,min}$ in.		Effective embedment h_{ef} in.	Minimum edge dist. $c_{a,min}$ in.	
			Cond. I	Cond. II		Cond. I	Cond. II		Cond. I	Cond. II		Cond. I	Cond. II
#3	18	5	14	8	5	14	7	5	14	7	5	14	6
#4		10	28	14	8	24	12	7	19	10	7	19	9
#5		18	52	27	16	47	24	13	38	19	10	28	14

1 Shaded embedment values exceed 20 bar diameters. For non-tabulated rebar sizes, design per development length provisions is recommended. The particular assumptions used for the application of anchor theory to bar development (e.g., bar yield and bond strength values) are a matter of engineering judgment and will in part depend on the specific circumstances of the design. For embedments corresponding to nominal yield (i.e., no overstrength) multiply the tabulated h_{ef} values by 0.86.

2 c_a is the minimum edge distance (from bar centerline) associated with the tabulated embedments and $s = 18$ in

3 Applicable for hammer-drilled holes.

4 Values are for normal weight concrete. For lightweight concrete contact Hilti.

5 Refer to the Hilti North America Post-Installed Reinforcing Bar Guide for further explanation, background information, and design examples. See Hilti Instructions for Use (IFU) for specific installation requirements.

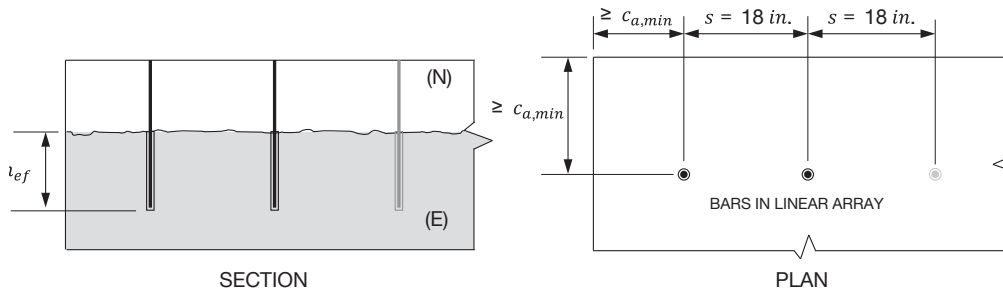

Figure 8 — Illustration of Table 62 dimensions

Table 63 — Suggested embedment and edge distance (see Figure 9) based on ACI 318-11 Appendix D to develop 125% of f_y in Grade 60 wall/column starter bars in a linear array with bar spacing = 12 inches — SDC A and B only^{1,2,3,4,5}

Rebar size	Linear spacing s in.	$f'_c = 2500$ psi				$f'_c = 3000$ psi				$f'_c = 4000$ psi				$f'_c = 6000$ psi			
		Effective embedment h_{ef} in.	Minimum edge dist. $c_{a,min}$ in.		Effective embedment h_{ef} in.	Minimum edge dist. $c_{a,min}$ in.		Effective embedment h_{ef} in.	Minimum edge dist. $c_{a,min}$ in.		Effective embedment h_{ef} in.	Minimum edge dist. $c_{a,min}$ in.		Effective embedment h_{ef} in.	Minimum edge dist. $c_{a,min}$ in.		
			Cond. I	Cond. II		Cond. I	Cond. II		Cond. I	Cond. II		Cond. I	Cond. II		Cond. I	Cond. II	
#3	12	7	19	10	6	16	9	5	14	7	5	14	6				
#4		-	-	-	13	40	20	11	33	16	8	25	12				

1 Shaded embedment values exceed 20 bar diameters. For non-tabulated rebar sizes, design per development length provisions is recommended. The particular assumptions used for the application of anchor theory to bar development (e.g., bar yield and bond strength values) are a matter of engineering judgment and will in part depend on the specific circumstances of the design. For embedments corresponding to nominal yield (i.e., no overstrength) multiply the tabulated h_{ef} values by 0.86.

2 c_a is the minimum edge distance (from bar centerline) associated with the tabulated embedments and $s = 12$ in

3 Applicable for hammer-drilled holes.

4 Values are for normal weight concrete. For lightweight concrete contact Hilti.

5 Refer to the Hilti North America Post-Installed Reinforcing Bar Guide for further explanation, background information, and design examples. See Hilti Instructions for Use (IFU) for specific installation requirements.

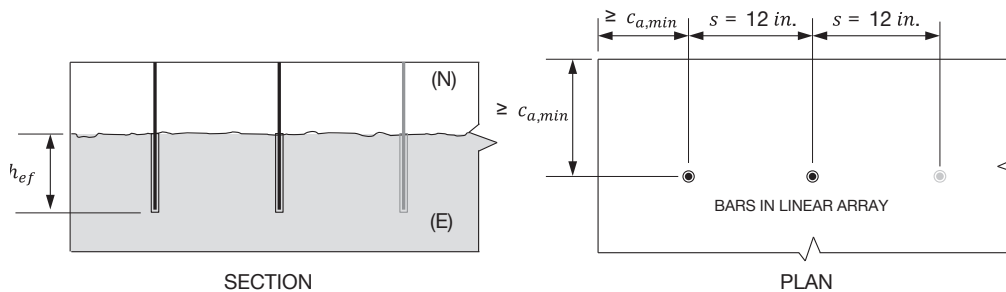

Figure 9 — Illustration of Table 63 dimensions

Table 64 — Calculated tension development and splice lengths for Canadian 400 MPa bars in walls, slabs, columns, and footings per CSA A23.3-14 for Hilti HIT-RE 100 — non-seismic design only^{3,4,5,6,7,8}



Rebar size	$d_{cs} + K_{tr}$	Min. edge dist. mm ¹	Min. spacing mm ²	$f'_c = 20$ MPa		$f'_c = 25$ MPa		$f'_c = 30$ MPa		$f'_c = 40$ MPa	
				ℓ_d mm	Class B splice mm	ℓ_d mm	Class B splice mm	ℓ_d mm	Class B splice mm	ℓ_d mm	Class B splice mm
10 M	2.5 d_b	60	50	300	380	300	340	300	310	300	300
15 M		70	75	410	540	370	480	340	440	300	380
20 M		80	100	510	660	450	590	410	540	360	460
25 M		120	125	820	1,060	730	950	670	870	580	750
30 M		130	150	960	1,250	860	1,120	790	1,020	680	890

1 Edge distances are determined using the minimum cover specified by ESR-3829 with an additional 6% of the development length per suggestions for drilling without an aid per Hilti Post-Installed Reinforcing Bar Guide Section 3.3. Smaller edge distances may be possible, for which development and splice lengths may need to be recalculated. For further information on required cover see CSA A23.1-14 Table 17; see Sec. 3.2 for determination of d_{cs} .

2 Spacing values represent those producing $c_b \geq 5d_b$. Smaller spacing values may be possible, for which development and splice lengths may need to be recalculated. For further information on required spacing see CSA A23.1 Sec. 6.6.5.2; see Sec. 3.2 for determination of d_{cs} .

3 k_1 and k_2 as defined by CSA A23.3-14 12.2.4 (a) and (b), are taken as 1.0 for post-installed reinforcing bars

4 $k_3 = 0.8$ for 20M bars and smaller bars, 1.0 for 25M and larger bars. See CSA A23.3-14 12.2.4 (d).

5 K_{tr} is assumed to equal zero.

6 Values are for normal weight concrete. For lightweight concrete, multiply development and splice lengths by 1.3.

7 Development and splice length values are for static design. For tension development and splice lengths of bars in joints, see CSA A23.3-14 21.3.3.5. For further information about reinforcement in seismic design, see CSA A23.3-14 Ch. 21.

8 Refer to the Hilti North America Post-Installed Reinforcing Bar Guide for further explanation, background information, and design examples.

Table 65 — Suggested embedment and edge distance (see Figure 10) based on CSA A23.3-14 Annex D to develop 125% of f_y in Canadian 400 MPa wall/column starter bars in a linear array with bar spacing = 600 millimeters — non-seismic design only^{1,2,3,4,5}



Rebar size	Linear spacing s mm	$f'_c = 20$ MPa			$f'_c = 25$ MPa			$f'_c = 30$ MPa			$f'_c = 40$ MPa		
		Effective embedment h_{ef} mm	Minimum edge dist. $c_{a,min}$ mm		Effective embedment h_{ef} mm	Minimum edge dist. $c_{a,min}$ mm		Effective embedment h_{ef} mm	Minimum edge dist. $c_{a,min}$ mm		Effective embedment h_{ef} mm	Minimum edge dist. $c_{a,min}$ mm	
			Cond. I	Cond. II		Cond. I	Cond. II		Cond. I	Cond. II		Cond. I	Cond. II
10M	600	150	430	220	140	410	200	140	400	190	130	390	180
15M		280	820	420	230	690	350	200	600	300	200	590	280
20M		510	1,490	760	430	1,270	650	380	1,120	570	310	900	460

- 1 Shaded embedment values exceed 20 bar diameters. For non-tabulated rebar sizes, design per development length provisions is recommended. The particular assumptions used for the application of anchor theory to bar development (e.g., bar yield and bond strength values) are a matter of engineering judgment and will in part depend on the specific circumstances of the design. For embedments corresponding to nominal yield (i.e., no overstrength) multiply the tabulated h_{ef} values by 0.86.
- 2 c_a is the minimum edge distance (from bar centerline) associated with the tabulated embedments and $s = 600$ mm.
- 3 Applicable for hammer-drilled holes.
- 4 Values are for normal weight concrete. For lightweight concrete contact Hilti.
- 5 Refer to the Hilti North America Post-Installed Reinforcing Bar Guide for further explanation, background information, and design examples. See Hilti Instructions for Use (IFU) for specific installation requirements.

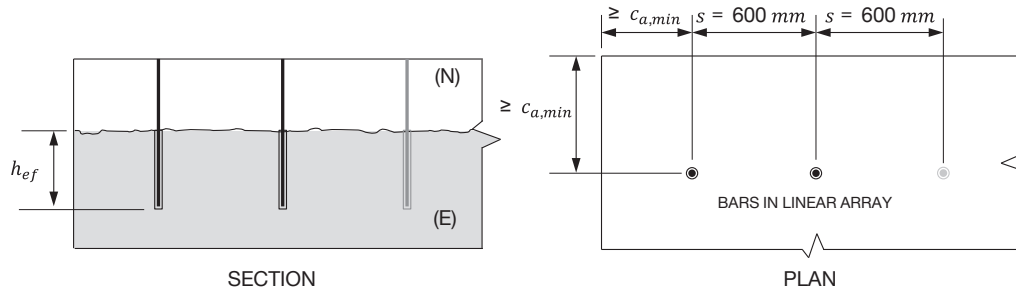

Figure 10 — Illustration of Table 65 dimensions



Table 66 — Suggested embedment and edge distance (see Figure 11) based on CSA A23.3-14 Annex D to develop 125% of f_y in Canadian 400 MPa wall/column starter bars in a linear array with bar spacing = 450 millimeters — non-seismic design only^{1,2,3,4,5}

Rebar size	Linear spacing s mm	$f'_c = 20$ MPa			$f'_c = 25$ MPa			$f'_c = 30$ MPa			$f'_c = 40$ MPa		
		Effective embedment h_{ef} mm	Minimum edge dist. $c_{a,min}$ mm		Effective embedment h_{ef} mm	Minimum edge dist. $c_{a,min}$ mm		Effective embedment h_{ef} in.	Minimum edge dist. $c_{a,min}$ mm		Effective embedment h_{ef} mm	Minimum edge dist. $c_{a,min}$ mm	
			Cond. I	Cond. II		Cond. I	Cond. II		Cond. I	Cond. II		Cond. I	Cond. II
10M	450	150	430	220	140	410	200	140	400	190	130	390	180
15M		390	1,170	590	340	1,010	500	300	890	440	240	720	360

1 Shaded embedment values exceed 20 bar diameters. For non-tabulated rebar sizes, design per development length provisions is recommended. The particular assumptions used for the application of anchor theory to bar development (e.g., bar yield and bond strength values) are a matter of engineering judgment and will in part depend on the specific circumstances of the design. For embedments corresponding to nominal yield (i.e., no overstrength) multiply the tabulated h_{ef} values by 0.86.

2 c_a is the minimum edge distance (from bar centerline) associated with the tabulated embedments and $s = 450$ mm.

3 Applicable for hammer-drilled holes.

4 Values are for normal weight concrete. For lightweight concrete contact Hilti.

5 Refer to the Hilti North America Post-Installed Reinforcing Bar Guide for further explanation, background information, and design examples. See Hilti Instructions for Use (IFU) for specific installation requirements.

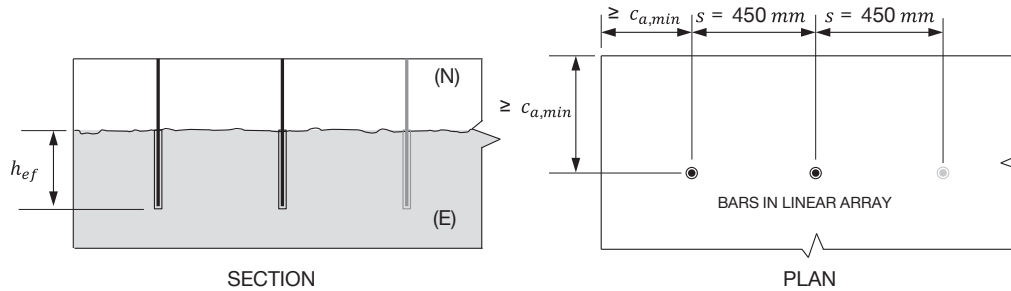

Figure 11 — Illustration of Table 66 dimensions

Table 67 — Suggested embedment and edge distance (see Figure 12) based on CSA A23.3-14 Annex D to develop 125% of f_y in Canadian 400 MPa wall/column starter bars in a linear array with bar spacing = 300 millimeters — non-seismic design only^{1,2,3,4,5}



Rebar size	Linear spacing s mm	$f'_c = 20$ MPa				$f'_c = 25$ MPa				$f'_c = 30$ MPa				$f'_c = 40$ MPa			
		Effective embedment h_{ef} mm	Minimum edge dist. $c_{a,min}$ mm		Effective embedment h_{ef} mm	Minimum edge dist. $c_{a,min}$ mm		Effective embedment h_{ef} in.	Minimum edge dist. $c_{a,min}$ mm		Effective embedment h_{ef} mm	Minimum edge dist. $c_{a,min}$ mm					
			Cond. I	Cond. II		Cond. I	Cond. II		Cond. I	Cond. II		Cond. I	Cond. II				
10M	300	240	700	350	200	600	300	180	520	260	150	440	210				

1 Shaded embedment values exceed 20 bar diameters. For non-tabulated rebar sizes, design per development length provisions is recommended. The particular assumptions used for the application of anchor theory to bar development (e.g., bar yield and bond strength values) are a matter of engineering judgment and will in part depend on the specific circumstances of the design. For embedments corresponding to nominal yield (i.e., no overstrength) multiply the tabulated h_{ef} values by 0.86.

2 c_a is the minimum edge distance (from bar centerline) associated with the tabulated embedments and $s = 300$ mm.

3 Applicable for hammer-drilled holes.

4 Values are for normal weight concrete. For lightweight concrete contact Hilti.

5 Refer to the Hilti North America Post-Installed Reinforcing Bar Guide for further explanation, background information, and design examples. See Hilti Instructions for Use (IFU) for specific installation requirements.

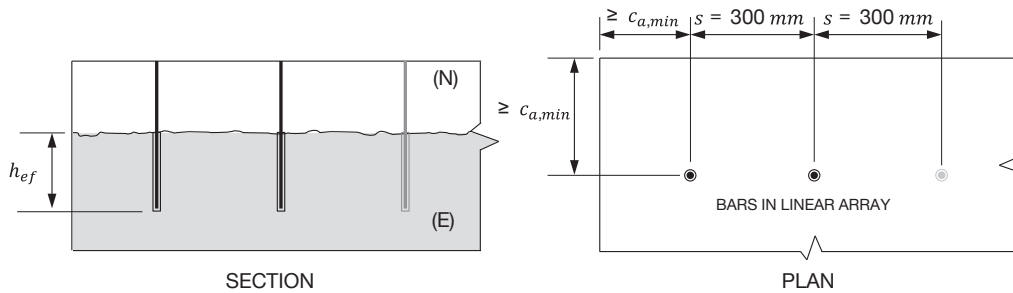

Figure 12 — Illustration of Table 67 dimensions

INSTALLATION INSTRUCTIONS

Operating Instruction or Installation Instructions For Use (IFU) are included with each product package. They can also be viewed or downloaded on-line at www.us.hilti.com (US) and www.hilti.ca (Canada) — “Service/Technical Info >> Technical Downloads >> Anchoring Systems”. Because of the possibility of changes, always verify that downloaded IFU are current when used. Proper installation is critical to achieve full performance. Training is available on request. Contact Hilti Technical Services for applications and conditions not addressed in the IFU.

MATERIALS SPECIFICATIONS

Table 68 — Material properties of fully cured HIT-RE 100 adhesive

Bond Strength ASTM C882-12 ¹ 2 day cure 14 day cure	20.1 Mpa 21.0 Mpa	2,920 psi 3,050 psi
Compressive Strength ASTM D695-10 ¹	74.3 Mpa	10,780 psi
Compressive Modulus ASTM D695-10 ¹	3,731 Mpa	0.541 x 10 ⁶ psi
Tensile Strength 7 day ASTM D638-10	11.7 Mpa	1,690 psi
Elongation at break ASTM D638-10	0.10%	
Heat Deflection Temperature ASTM D648-07	56.8°C	134.3°F
Absorption ASTM D570-10	0.06%	
Linear Coefficient of Shrinkage on Cure ASTM D2566-86	0.0001	

¹ Minimum values obtained as the result of tests at 35°F, 50°F, 75°F and 110°F.

Table 69 — Resistance of HIT-RE 100 to chemicals

Chemical	Chemicals Tested	Resistant	Not Resistant
Alkaline	Concrete drilling mud (10%) pH=12.6	+	
	Concrete drilling mud (10%) pH=13.2	+	
	Concrete potash solution (10%) pH=14.0	+	
Alkaline	Acetic acid (10%) ¹		-
	Nitric acid (10%) ¹		-
	Hydrochloric acid (10%) 3 month		-
	Sulfuric acid (10%)		-
Solvents	Benzyl alcohol		-
	Ethanol		-
	Ethyl acetate		-
	Methyl ethyl ketone (MEK)		-
	Trichlorethylene		-
Chemicals used on job sites	Xylene (mixture)	+	
	Chemicals Concrete plasticizer	+	
	used on job Diesel oil	+	
	sites Oil	+	
	Petrol	+	
Environmental chemicals	Oil for form work (forming oil)	+	
	Environmental Salt water	+	
	chemicals	+	
	de-mineralized water	+	
	salt spraying test	+	
SO ₂	+		
Environment/ weather	+		

¹ Concrete was dissolved by acid

Samples of the HIT-RE 100 resin were immersed in the various chemical compounds for up to one year. At the time of the test period, the samples were analyzed. Any samples showing no visible damage and having less than a 25% reduction in bending (flexural) strength were classified as “**Resistant.**” Samples that were heavily damaged or destroyed were classified as “**Not Resistant.**”

Note: In actual use, the majority of the resin is encased in the base material, leaving very little surface area exposed.

**Table 70 — HIT-RE 100 Ultimate Tensile Bond Strength for Smooth Epoxy Coated Dowel Bars in Concrete
 ≥ 2410 psi (15.9 MPa)**

Anchor Diameter in. (mm)	Drill Bit Diameter in. (mm)	Embedment Depth in. (mm)	Ultimate Tensile Load lb (kN)
1 (25.4)	1-1/8 (29)	9 (229)	40385 (179.7)
1-1/4 (31.8)	1-3/8 (34.9)		
1-1/2 (38.1)	1-5/8 (41)		



Hilti, Inc. (U.S.) 1-800-879-8000
en español 1-800-879-5000
www.hilti.com

Hilti (Canada) Corporation 1-800-363-4458
www.hilti.ca